



FES Brands North America

Commercial Kitchen Supply



Who are we

At FES Brands North America, we focus on providing private label services to dealers in the food service and hospitality industry. Our deep product knowledge and strong ties with many original equipment manufacturers enable us to achieve the business goal that strike outstanding balance between quality and cost of products. We offer a wide variety of products that adhere to the food service industry standard. Our all-inclusive private label services include product sourcing, manufacturing, and logistics handling. In addition, we collaborate with partners to develop new products, and provide opportunity to strengthen their brand value and achieve outmost profit margins.

Copyright© 2024 FES Brands North America®

All rights reserved.

hello@fesbrands.us | [FESbrands.us](https://fesbrands.us) | 470-709-4628

Product images & specification subject to change without notice

2024 Catalog Table of Contents

| | |
|--|----|
| ATS Quickship | 1 |
| Plain Back Upholstered Booths | 2 |
| QUICKSHIP Wood Platform Booths | 5 |
| Metal Chairs..... | 7 |
| Swivel Barstools | 8 |
| Build Your Own | 9 |
| Outdoor Furniture | 10 |
| Aluminum Furniture | 13 |
| Isotop Outdoor/Indoor Table Tops..... | 14 |
| Double Side 2” Laminated Panel Table Tops..... | 15 |
| Reversible Table Tops | 16 |
| Self Edge Laminated Table Tops | 17 |
| Resin Table Tops | 18 |
| High Chairs / Hostess Stations / Trash Receptacles | 19 |
| TABLE BASES | 20 |
| 2-PC Indoor & Outdoor Table Base Kits | 22 |
| Table Base Parts | 23 |
| Miscellaneous | 24 |
| FLO Faucets | 29 |
| Heavy Duty Pre-Rinse Faucet..... | 30 |
| Wall Mount Faucet..... | 32 |
| Handle Waste Valve with Strainer | 35 |
| Operation Valve..... | 36 |
| Wok Range Faucet | 37 |
| Service Sink Faucet | 38 |
| MET Stainless Steel | 39 |
| Wall Mount Hand Sinks..... | 40 |
| Compartment Sinks..... | 41 |
| Dish Tables | 45 |
| Work Tables..... | 46 |
| S/S Work Table Undershelf | 49 |
| Equipment Stand | 50 |
| S/S Wall Shelves..... | 52 |
| S/S Double Overshelf | 53 |
| S/S Cabinet | 53 |
| Tubular Dish Drainage Shelf..... | 54 |
| Beverage Table with Urn Troughs..... | 55 |

| | |
|------------------------------|----|
| Pot Racks..... | 55 |
| Sinks..... | 56 |
| Underbar | 58 |
| Keg Racks..... | 61 |
| Utility Carts..... | 61 |
| Green Shelf..... | 62 |
| Bun Racks..... | 63 |
| Hood Filters..... | 63 |
| Accessories..... | 64 |
| Green Shelf..... | 66 |
| Steam Table Pan & Cover..... | 67 |

| | |
|------------------------|-----------|
| LIT..... | 68 |
| Wood Underliners | 69 |
| Aprons | 70 |

| | |
|------------------------------|-----------|
| Plasticware..... | 71 |
| Dishwasher Racks | 72 |
| Trash Cans / Containers..... | 73 |
| Servewares | 77 |
| Bar Supplies..... | 77 |

| | |
|-----------------------|-----------|
| Chinaware..... | 79 |
|-----------------------|-----------|

| | |
|---|-----------|
| LIT Cooking..... | 82 |
| FreeStanding Electric Strip Heaters | 83 |
| Strip Heaters Hardwares..... | 83 |
| Countertop Warmer | 84 |
| Chip Warmer | 84 |
| Convection Ovens..... | 85 |
| Can Racks..... | 86 |
| Reach-in Refrigerator Storage Pan Rack..... | 86 |
| Bun Pan Racks..... | 87 |
| Warming Drawer | 88 |
| Can Opener..... | 89 |
| Film Wrapping Dispenser | 89 |
| Pro Swinging Traffic Door..... | 90 |
| Wok Range..... | 90 |
| Heated Holding & Proofing Cabinet..... | 91 |

Product Line

ATS - Furniture



FLO - Faucets Supplies



MET - Stainless Steel Equipment



LIT / Watson - Plasticware & Chinaware & Cooking Equipment





ATS Quickship

Plain Back Upholstered Booths

Quickship



QAS-36 Deep Red



QAD-42 Black



QAS-36 Grey



QAD-36 Green



QAS-36 Brown

Plain Back Upholstered Booths Only

| Model # | Type | Height | Weight (lb) |
|---------|--------|--------|-------------|
| QAS-36 | Single | 36" | 80 |
| QAS-42 | | 42" | 85 |
| QAD-36 | Double | 36" | 115 |
| QAD-42 | | 42" | 120 |

Available Vinyl Colors :

| | | | | | | |
|---|---|---|---|--|---|---|
|  |  |  |  |  |  |  |
| Black Tsunami-ARM-126-M | Deep Red Sangria-ARM-120-M | Bright Red Red-IND-053 | Grey Gunmetal-IND-8619 | Green Forest Green-IND-8571 | Brown Mocha-IND-8406 | Yellow Yellow-IND-050 |

Plain Back Upholstered Booths

Quickship Booths with Top and End Caps



QAS-36-TEC Gunmetal



QAS-42-TEC Mocha

| Quick Ship Booth w/ Top Cap Only | | | | |
|----------------------------------|------------|--------|--------|-----|
| Model # | Cap Finish | Type | Height | lbs |
| QAS-36-TC | N | Single | 36" | 85 |
| QAS-42-TC | DM | | 42" | 90 |
| QAD-36-TC | W | Double | 36" | 120 |
| QAD-42-TC | BLK | | 42" | 225 |
| | C | | | |

| Quick Ship Booth w/ Two End Caps | | | | |
|----------------------------------|------------|--------|--------|-----|
| Model # | Cap Finish | Type | Height | lbs |
| QAS-36-EC | N | Single | 36" | 90 |
| QAS-42-EC | DM | | 42" | 95 |
| QAD-36-EC | W | Double | 36" | 125 |
| QAD-42-EC | BLK | | 42" | 130 |
| | C | | | |

| Quick Ship Booth w/ Top & Two End Caps | | | | |
|--|------------|--------|--------|-----|
| Model # | Cap Finish | Type | Height | lbs |
| QAS-36-TEC | N | Single | 36" | 95 |
| QAS-42-TEC | DM | | 42" | 100 |
| QAD-36-TEC | W | Double | 36" | 130 |
| QAD-42-TEC | BLK | | 42" | 135 |
| | C | | | |

**Please specify the cap finish color when ordering booth with caps: DM, N, W, BLK, C

Available Vinyl Colors :



*Available Cap Colors:

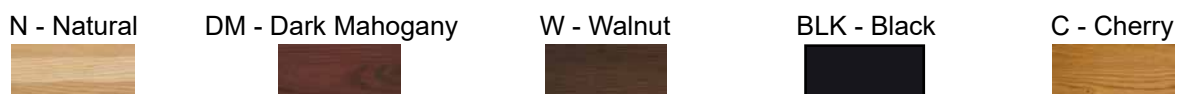

Plain Back Upholstered Booths

Three Button Back Upholstered Booths



QAS-36TB-3



QAS-42TB-3-TEC
*Featured with optional DM Top and End Cap

| Quick Ship Three Button Back Upholstered Booth Only | | | | |
|---|------------|--------|--------|-----|
| Model # | Cap Finish | Type | Height | lbs |
| QAS-36TB-3 | N | Single | 36" | 80 |
| QAS-42TB-3 | DM | | 42" | 85 |
| QAD-36TB-3 | W | Double | 36" | 115 |
| QAD-42TB-3 | BLK | | 42" | 120 |
| | C | | | |

| Quick Ship Three Button Back Upholstered Booth w/ Both Top and End Caps | | | | |
|---|------------|--------|--------|-----|
| Model # | Cap Finish | Type | Height | lbs |
| QAS-36TB-3-TEC | N | Single | 36" | 95 |
| QAS-42TB-3-TEC | DM | | 42" | 100 |
| QAD-36TB-3-TEC | W | Double | 36" | 130 |
| QAD-42TB-3-TEC | BLK | | 42" | 135 |
| | C | | | |

**Please specify the cap finish color when ordering booth with caps: DM, N, W, BLK, C

Available Vinyl Colors:





*Available Cap Colors:



QUICKSHIP Wood Platform Booths

| Wood Platform Booth Only | | | | | |
|--|--------------|---------|--------|--------|-----|
|  AWS-48-DM | Frame Finish | Model # | Type | lbs | |
| | DM | | AWS-48 | Single | 85 |
| | | | AWS-60 | | 98 |
| | | | AWS-72 | | 111 |
| | W | | AWD-48 | Double | 142 |
| | | | AWD-60 | | 163 |
| | | | AWD-72 | | 183 |

| Wood Platform Booth w/ Seat Pad | | | | | |
|--|--------------|---------|-----------|--------|-----|
|  AWD-48WS-W | Frame Finish | Model # | Type | lbs | |
| | DM | | AWS-48-WS | Single | 102 |
| | | | AWS-60-WS | | 117 |
| | | | AWS-72-WS | | 132 |
| | W | | AWD-48-WS | Double | 176 |
| | | | AWD-60-WS | | 201 |
| | | | AWD-72-WS | | 225 |

| Wood Platform Booth w/ Back Pad | | | | | |
|---|--------------|---------|-----------|--------|-----|
|  AWD-48WB-DM (Back with -COM Shown) | Frame Finish | Model # | Type | lbs | |
| | DM | | AWS-48-WB | Single | 94 |
| | | | AWS-60-WB | | 109 |
| | | | AWS-72-WB | | 125 |
| | W | | AWD-48-WB | Double | 160 |
| | | | AWD-60-WB | | 185 |
| | | | AWD-72-WB | | 211 |

| Wood Platform Booth w/ Seat and Back Pads | | | | | |
|--|--------------|---------|------------|--------|-----|
|  AWD-48WSB-W | Frame Finish | Model # | Type | lbs | |
| | DM | | AWS-48-WSB | Single | 111 |
| | | | AWS-60-WSB | | 128 |
| | | | AWS-72-WSB | | 146 |
| | W | | AWD-48-WSB | Double | 194 |
| | | | AWD-60-WSB | | 223 |
| | | | AWD-72-WSB | | 253 |

Finish Codes: **DM**-Dark Mahogany **W**-Walnut

Wood Platform Booth Vinyl Pad Options

Platform Booth Back Pad Options

| Model # (Standard) | Description | lbs |
|--------------------|---|-----|
| BACK-PAD-AWSD-48 | Back Pad for 48" Wood Platform Booth (EACH) | 9 |
| BACK-PAD-AWSD-60 | Back Pad for 60" Wood Platform Booth (EACH) | 11 |
| BACK-PAD-AWSD-72 | Back Pad for 72" Wood Platform Booth (EACH) | 14 |

Platform Booth Seat Pad Options

| Model # (Standard) | Description | lbs |
|--------------------|---|-----|
| SEAT-PAD-AWSD-48 | Seat Pad for 48" Wood Platform Booth (EACH) | 17 |
| SEAT-PAD-AWSD-60 | Seat Pad for 60" Wood Platform Booth (EACH) | 19 |
| SEAT-PAD-AWSD-72 | Seat Pad for 72" Wood Platform Booth (EACH) | 21 |

Metal Chairs

Quickship Chairs Seat Unattached

Ship in 5 Business Days

| 1 Year Frame Structural Warranty | Frame Coat | H A H A | Model # | Vinyl Seat Colors | lbs |
|--|-------------------|---------------|-----------|---|---|
|  77-YL-BLK  77-BS-YL-BLK | Black Powder Coat | 32 18.5 17 17 | 77-YL |  -BLK | 19 |
| | | | 77-BS-YL | |  -RED  -RED  -GRY  -GRN  -BRN  -YLW |
|  77C-YL-BLK  77C-BS-YL-BLK | Clear Coat | 32 18.5 17 17 | 77C-YL |  -RED  -GRY  -GRN  -BRN  -YLW | 19 |
| | | | 77C-BS-YL | |  -BLK  -RED  -RED  -GRY  -GRN  -BRN  -YLW |
|  78-YL-BLK  78-BS-YL-BLK | Black Powder Coat | 32 18.5 17 17 | 78-YL |  -BLK  -RED  -RED  -GRY  -GRN  -BRN  -YLW | 19 |
| | | | 78-BS-YL | |  -BLK  -RED  -RED  -GRY  -GRN  -BRN  -YLW |
|  85-YL-BLK  85-BS-YL-BLK | Black Powder Coat | 34 18.5 17 17 | 85-YL |  -BLK  -RED  -RED  -GRY  -GRN  -BRN  -YLW | 19 |
| | | | 85-BS-YL | |  -BLK  -RED  -RED  -GRY  -GRN  -BRN  -YLW |
|  87-YL-BLK  87-BS-YL-BLK | Black Powder Coat | 34 18.5 17 17 | 87-YL |  -BLK  -RED  -RED  -GRY  -GRN  -BRN  -YLW | 19 |
| | | | 87-BS-YL | |  -BLK  -RED  -RED  -GRY  -GRN  -BRN  -YLW |

* All Quickship Metal Chairs come with standard vinyl seat unattached. 3/4" seat mounting screws included.

Swivel Barstools

Quickship

| | Model # (Seat Attach) | W x D x H | lbs |
|---|--------------------------|---|-----|
|  | SR-2 (-UNA / -ATT) | Bottom Frame: 13" x 18" x 26" Seat: 14" R x 4" H | 15 |
|  | SR-3 (-UNA / -ATT) | Bottom Frame: 13" x 18" x 26" Seat: 16" x 16" x 17" | 22 |
|  | SR-8 (-UNA / -ATT) | Bottom Frame: 13" x 18" x 26" Seat: 14" R x 4.5" H | 18 |
|  | SR-4J (-UNA / -ATT) | Bottom Frame: 17" x 23" x 26" Seat: 19" x 18" x 18" | 32 |
|  | SR-5J (-UNA / -ATT) | Bottom Frame: 13" x 18" x 26" Seat: 19" x 18" x 17" | 32 |

* -UNA are unattached seat & -ATT are attached seats

* ATS' Swivel Barstools with double ring bases are constructed of 1" chrome plated round steel tubing.

* Black Cross-over Bases are constructed of round tapered tubing with black enamel finish.

* All barstools use a flat swivel plate. Barstool bases are fully assembled

* CAL133 (California Tech Bulletin) upholstery. Not available on black vinyl seat

Build Your Own

QuickShip

Swivel Barstool Seats

| | | Model # | Descriptions | lbs |
|---|---|---------|---|-----|
|  |  | SR-2B-S | 4" H, 14" R Black Vinyl Seat | 4 |
|  |  | SR-5B-J | 17" H, 19" W, 18" D Black Vinyl Jumbo Seat | 21 |
| | | SR-3B-S | Seat with Back Frame: 17" H, 16" W, 16" D Seat Radius ONLY: 14"R x 4.5"H | 11 |
|  |  | SR-8-S | 4.5" H, 15" R Black Vinyl Seat (GR 4) | 7 |

Swivel Barstool Bases

| | | Model # | Descriptions | lbs |
|---|---|---------|---|-----|
|  |  | SR-CF | 2 Ring Chrome Frame | 11 |
| | | SR-BF | Gloss Black Metal Frame w/ Chrome Ring | 10 |

Swivel Plate

| | | Model # | Descriptions | lbs |
|---|---------|---------|---------------------------------|-----|
|  | SR-3DEG | SR-3DEG | 3 Degree Tilted Swivel Plate | 3 |
|  | SR-FLAT | SR-FLAT | Level Swivel Plate | 3 |

Outdoor Furniture

BLACK Powder Coat Finish

**1 Year
Limited Warranty**



Model#

Description

lbs

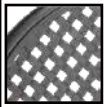

90B



90B-BS

34.0
17.5
16.0
16.5

90B

Black Powder Coated Metal Chair

13

43.5
27.5
16.5
16.0

90B-BS

Black Powder Coated Metal Barstool

18



91

33.0
17.5
16.5
17.5

91

Black Powder Coated Metal Chair

13



92



92-BS

32.0
18.0
16.5
17.0

92

Black Powder Coated Metal Chair

13

44.5
29.5
17.0
19.0

92-BS

Black Powder Coated Metal Barstool

17

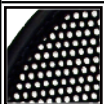

93

35.0
19.0
18.0
17.5

93

Black Powder Coated Metal Chair

13



94



94-BS

34.0
18.5
18.0
17.5

94

Black Powder Coated Metal Chair

12

46.0
30.0
18.0
17.5

94-BS

Black Powder Coated Metal Barstool

16

** Use outdoor chairs / barstools on flat floor surface only. Maximum weight capacity : 250 lbs

Outdoor Furniture

GREY Powder Coat Finish

**1 Year
Limited Warranty**



Model#

Description

lbs

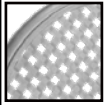

90G

34.0
17.5
16.0
16.5

90G

Grey Powder Coated
Metal Chair

13

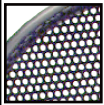

91G

33.0
17.5
16.5
17.5

91G

Grey Powder Coated
Metal Chair

13

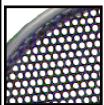

92G

32.0
18.0
16.5
17.0

92G

Grey Powder Coated
Metal Chair

13



ALM30-GRY

30" round Open Mesh top
30" height outdoor table GREY
Finish

40

ALM3030-GRY

30" x 30" Square Open Mesh
top
30" height outdoor table GREY
Finish

42

ALM36-GRY

36" round Open Mesh top
30" height outdoor table GREY
Finish

50

ALM3636-GRY

36" x 36" Square Open Mesh
top 30" height outdoor table
GREY Finish

52

ALM3048-GRY

30" x 48" rectangle Open Mesh
top 30" height outdoor table
GREY Finish

44



** ATS Outdoor Table Feature extra heavy-duty metal construction with a deep textured - Grey powder coat finish
** Use outdoor chairs / barstools on flat floor surface only. Maximum weight capacity : 250 lbs

Outdoor Furniture

BLACK Powder Coat Finish

|  | Model# | Description | lbs |
|---|----------|---|-----|
|  | AB30 | 30" round Fine Mesh top standard height outdoor table | 29 |
| | AB3030 | 30" x 30" square Fine Mesh top standard height outdoor table | 33 |
| | AB36 | 36" round Fine Mesh top standard height outdoor table | 37 |
| | AB3636 | 36" x 36" square Fine Mesh top standard height outdoor table | 38 |
| | AB3048 | 30" x 48" rectangular Fine Mesh top standard height outdoor table | 44 |
| | ABB30 | 30" round Fine Mesh top bar height outdoor table | 36 |
|  | ALM30 | 30" round Open Mesh top standard height outdoor table - BLACK Finish | 40 |
| | ALM3030 | 30" x 30" Square Open Mesh top standard height outdoor table - BLACK Finish | 42 |
| | ALM36 | 36" round Open Mesh top standard height outdoor table - BLACK Finish | 50 |
| | ALM3636 | 36" x 36" Square Open Mesh top standard height outdoor table - BLACK Finish | 52 |
| | ALM3048 | 30" x 48" rectangle Open Mesh top standard height outdoor table - BLACK Finish | 44 |
|  | OMT-30 | 30" round Wire Mesh top standard height outdoor table - BLACK Finish | 40 |
| | OMT-3030 | 30" x 30" Square Wire Mesh top standard height outdoor table - BLACK Finish | 42 |
| | OMT-36 | 36" round Wire Mesh top standard height outdoor table - BLACK Finish | 50 |
| | OMT-3636 | 36" x 36" square Wire Mesh top standard height outdoor table - BLACK Finish | 52 |
| | OMT-3048 | 30" x 48" rectangle Wire Mesh top standard height outdoor table - BLACK Finish | 44 |
|  | UMB-GRN | Green Umbrella for Outdoor Table With Umbrella Hole (Table Sold Separately) Dimension: 95" R x 102.5" H | 69 |
| | UMB-RED | Red Umbrella for Outdoor Table With Umbrella Hole (Table Sold Separately) Dimension: 95" R x 102.5" H | 69 |
| | UMB-BUR | Burgundy Umbrella for Outdoor Table With Umbrella Hole (Table Sold Separately) Dimension: 95" R x 102.5" H | 69 |

** ATS Outdoor Table Feature extra heavy-duty metal construction with a deep textured - Black powder coat finish

** Standard height 30" & Bar height 42"

Aluminum Furniture

Quickship

**1 Year
Limited Warranty**

Model#

Description

lbs



AL30

27.5" Round Top
Standard Height Column

24

AL30H

27.5" Round Top
Bar Height Column

30



AL3030

27.5" x 27.5" Square Top
Standard Height Column

34



AL3048

27.5" x 45.5" Rectangular Top
Standard Height Column

40

* ATS Aluminum Furniture feature extra durable welded aluminum seating, and modern patterns.
* 1 Year limited warranty.

Isotop Outdoor/Indoor Table Tops

Quickship

Ship in 5 business days

**1 Year
Limited Warranty**



Aged Pine
(-201)



Compressed Grey
(-207)



Alcantara Black
(-202)



Grey Oak
(-212)



Indian Rose
(-213)



Pearl White
(-214)

| Model # | Size | lbs |
|--|---------------|-----|
| ATO2828 (-201, -202, -207, -212, -213, -214) | 27.5" x 27.5" | 19 |
| ATO3048 (-201, -202, -207, -212, -213, -214) | 31.5" x 47.2" | 41 |
| ATO3636 (-201, -202, -207, -212, -213, -214) | 35.5" x 35.5" | 32 |
| ATO28 (-201, -202, -207, -212, -213, -214) | 27.5" | 17 |
| ATO36 (-201, -202, -207, -212, -213, -214) | 35.5" | 25 |
| ATO48 (-201, -202, -207, -212, -213, -214) | 47.2" | 45 |

** Thickness: 35mm (approximately 1.4") Indoor/Outdoor Tops - 1 Year limited warranty.

** 1/2" mounting screws included if order with ATS Table bases

** No screw included if order table tops only

Double Side 2" Laminated Panel Table Tops

Quickship

Ship in 5 business days

**1 Year
Limited Warranty**

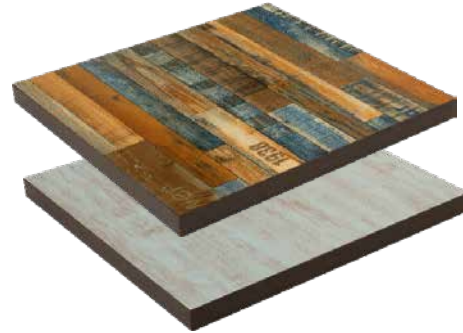

| Model # | Size | lbs |
|--------------|-----------|------|
| ATP2430-BL/Y | 24" x 30" | 22 |
| ATP3045-BL/Y | 30" x 45" | 38.5 |
| ATP3048-BL/Y | 30" x 48" | 40 |
| ATP3060-BL/Y | 30" x 60" | 52 |
| ATP3072-BL/Y | 30" x 72" | 61.5 |
| ATP3030-BL/Y | 30" x 30" | 27 |
| ATP3636-BL/Y | 36" x 36" | 36 |
| ATP30-BL/Y | 30" R | 23 |
| ATP36-BL/Y | 36" R | 30 |

** Thickness: 2" composite vinyl drop edge indoor tops - 1 year limited warranty

** Double side laminated light blue wood grain / yangon color planks finish

** 3/4" mounting screws included if order with ATS Table bases

** No screw included if order table tops only

Reversible Table Tops

Quickship

Ship in 5 business days



B/DM - Black & Dark Mahogany



GY/BN - Grey & Brown

| Size | Model # | lbs |
|-----------|-----------------------------------|-----|
| 24" X 30" | ADL2430 (-B/DM, -GY/BN) | 19 |
| 30" X 30" | ADL3030 (-B/DM, -GY/BN) | 23 |
| 30" X 45" | ADL3045 (-B/DM, -GY/BN) | 34 |
| 30" X 48" | ADL3048 (-B/DM, -GY/BN) | 37 |
| 30" X 60" | ADL3060 (-B/DM, -GY/BN) | 47 |
| 30" X 66" | ADL3066 (-GY/BN) | 56 |
| 30" X 72" | ADL3072 (-B/DM, -GY/BN) | 57 |
| 36" X 36" | ADL3636 (-B/DM, -GY/BN) | 34 |
| 24" R | ADL24 (-B/DM, -GY/BN) | 12 |
| 30" R | ADL30 (-B/DM, -GY/BN) | 19 |
| 36" R | ADL36 (-B/DM, -GY/BN) | 27 |
| 42" R | ADL42 (-B/DM, -GY/BN) | 37 |
| 48" R | ADL48 (-B/DM, -GY/BN) | 48 |

** 1" thickness - melamine surface

** 3/4" mounting screws included if order with ATS Table bases

** No screw included if order table tops only

Self Edge Laminated Table Tops

Quickship

Ship in 5 business days



| Size | Model # | lbs |
|-----------|------------|-----|
| 24" X 30" | ATE2430-GY | 24 |
| 30" X 30" | ATE3030-GY | 29 |
| 30" X 45" | ATE3045-GY | 46 |
| 30" X 48" | ATE3048-GY | 50 |
| 30" X 60" | ATE3060-GY | 55 |
| 30" X 66" | ATE3066-GY | 62 |
| 30" X 72" | ATE3072-GY | 65 |
| 36" X 36" | ATE3636-GY | 45 |
| 24" R | ATE24-GY | 22 |
| 30" R | ATE30-GY | 26 |
| 36" R | ATE36-GY | 37 |
| 42" R | ATE42-GY | 49 |
| 48" R | ATE48-GY | 60 |

** 2 inch thickness & laminate surface

** 3/4" mounting screws included if order with ATS Table bases

** No screw included if order table tops only

Resin Table Tops

Quickship

Ship in 5 business days



M - Mahogany



C/M - Cherry / Mahogany



VTW - Vintage Walnut



W - Walnut



Y/G - Yellow Green



WH - White Marble



PW - Pure White

Standard Corners are eased edges as shown. Customization are not available.

| Size | Model# | lbs |
|-----------|--|-----|
| 24" x 30" | ATR2430 (-M, -C/M, -VTW, -W, -Y/G, -PW) | 30 |
| 30" X 30" | ATR3030 (-M, -C/M, -VTW, -W, -Y/G, -WH, -PW) | 37 |
| 30" X 45" | ATR3045 (-M, -C/M, -VTW, -W, -Y/G, -WH, -PW) | 53 |
| 30" X 48" | ATR3048 (-M, -C/M, -VTW, -W, -Y/G, -PW) | 59 |
| 30" X 60" | ATR3060 (-M, -C/M, -VTW, -W, -Y/G, -WH, -PW) | 74 |
| 30" X 66" | ATR3066 (-Y/G, -WH) | 78 |
| 30" X 72" | ATR3072 (-M, -C/M, -VTW, -W, -Y/G, -WH, -PW) | 82 |
| 36" X 36" | ATR3636 (-M, -C/M, -VTW, -W, -Y/G, -WH, -PW) | 51 |
| 24" R | ATR24 (-M, -C/M, -VTW, -W, -Y/G, -PW) | 17 |
| 30" R | ATR30 (-M, -C/M, -VTW, -W, -Y/G, -PW) | 28 |
| 36" R | ATR36 (-M, -C/M, -VTW, -W, -Y/G, -PW) | 33 |
| 48" R | ATR48 (-M, -C/M, -W) | 76 |

** 2 inch thickness & resin Surface

** 3/4" mounting screws included if order with ATS Table bases

** No screw included if order table tops only

High Chairs / Hostess Stations / Trash Receptacles

High Chairs

| | Frame Finish | Model # | lbs |
|--|-----------------|---------|-----|
|  <div style="display: flex; justify-content: space-around; width: 100%;"> N W DM </div> | -DM -N -W | HCW | 14 |

Finish Codes: **DM**-Dark Mahogany **N**-Natural **W**-Walnut

Hostess Stations

| | Model # | Type | lbs |
|---|---------|----------------------------------|-----|
|  <div style="display: flex; justify-content: space-around; width: 100%;"> WS1-BLK WS1-GRY </div> | WS1-BLK | Melamine Waitress Station, Black | 105 |
| | WS1-GRY | Melamine Waitress Station, Grey | 105 |

Trash Receptacles (with Liner)

| | Model # | Type | lbs |
|--|----------|----------------------------------|-----|
|  <div style="display: flex; justify-content: space-around; width: 100%;"> TR1-BLK TR1-GRY </div> | TR1-BLK | Melamine Trash Receptacle, Black | 105 |
| | TR1-GRY | Melamine Trash Receptacle, Grey | 105 |
| | TR-LINER | Trash Receptacle Liner | 2 |

- ATS Trash Receptacles are built of a strong reinforced particle board core to withstand years of use. It includes a 32 gallon liner.
- TR1-BLK, Black Color w/ White "THANK YOU" Only, no custom color available. Built with Black Top Rails.
- TR1-GRY, Grey Color w/ Black "THANK YOU" Only, no custom color available.

ATS MFG

TABLE BASES

3-PC Indoor & Outdoor Table Base Kits

Limited Life Time
Warranty
for All Table Bases



T0522
T0522-BAR



T2222, T2222-BAR
T2230, T2230-BAR
T3030, T3030-BAR
T3636, T3636-BAR



TR18, TR18-BAR
TR22, TR22-BAR
TR30, TR30-BAR



With Foot Ring

| Model # | Description | lbs |
|---|---|-----|
| 3-PC Easy Assembly Indoor & Outdoor Table Base Kits | | |
| T0522 | 5" x 22" with 3" Dia. Column | 14 |
| T2222 | 22" x 22" with 3" Dia. Column | 14 |
| T2230 | 22" x 30" with 3" Dia. Column | 19 |
| T3030 | 30" x 30" with 3" Dia. Column | 19 |
| T3636 | 36" x 36" with 4" Dia. Column | 32 |
| TR18 | 18" R with 3" Dia. Column | 23 |
| TR22 | 22" R with 4" Dia. Column | 45 |
| TR30 | 30" R with 4" Dia. Column | 57 |
| Bar Height 3-PC Easy Assembly Indoor & Outdoor Table Base Kits | | |
| T0522-BAR | 5" x 22" with 3" Bar Height Column | 17 |
| T2222-BAR | 22" x 22" with 3" Bar Height Column | 17 |
| T2230-BAR | 22" x 30" with 3" Bar Height Column | 22 |
| T3030-BAR | 30" x 30" with 3" Bar Height Column | 22 |
| T3636-BAR | 36" x 36" with 4" Bar Height Column | 37 |
| TR18-BAR | 18" R. with 3" Bar Height Column | 26 |
| TR22-BAR | 22" R. with 4" Bar Height Column | 49 |
| TR30-BAR | 30" R. with 4" Bar Height Column | 61 |
| Add-on Accessory | | |
| TF-3R | Indoor Table Base Foot Ring (3" Diameter) | 7 |
| TF-4R | Indoor Table Base Foot Ring (4" Diameter) | 9 |

Recommended 3-PC Base Size By Table Top Size

| Top Size | Recom. Base | Top Size | Recom. Base | Top Size | Recom. Base | Top Size | Recom. Base |
|-----------|--------------------------|-----------|--------------------------|-----------|------------------------------|-----------|---------------------|
| 24" Round | T2222 or TR18 | 30" Round | T2222 or TR22 | 36" Round | T3030 or TR22 | 42" Round | T3636 or TR30 |
| 24" x 24" | | 30" x 30" | | 36" x 36" | | 42" x 42" | |
| 24" x 30" | T2230 | 30" x 42" | T2230 or TR22 | 36" x 48" | T0522 (2) or TR22 | 48" Round | |
| 24" x 42" | T0522 (2) or T2230 | 30" x 45" | | | | | |
| 24" x 48" | | 30" x 48" | T0522 (2) or T2230 | 30" x 60" | T2222 (2) or T2230 (2) | | |
| 24" x 60" | T0522 (2) | | | 30" x 72" | | | |

**Limited life time warranty for all table bases. Please contact us for more info

**Standard Base Height: 28 1/2", Bar Height: 40 1/4"

**See packing and handling fee page for pallet fee schedule info

2-PC Indoor & Outdoor Table Base Kits

Limited Life Time
Warranty
for All Table Bases



T0522M
T0522M-BAR



T2222M, T2222M-BAR
T2230M, T2230M-BAR
T3030M, T3030M-BAR
T3636M, T3636M-BAR



TR18M, TR18M-BAR
TR22M, TR22M-BAR
TR30M, TR30M-BAR



With Foot Ring

| Model # | Description | lbs |
|---|---|-----|
| 2-PC Easy Assembly Indoor & Outdoor Table Base Kits | | |
| T0522M | 5" x 22" with 3" Dia. Column | 14 |
| T2222M | 22" x 22" with 3" Dia. Column | 14 |
| T2230M | 22" x 30" with 3" Dia. Column | 19 |
| T3030M | 30" x 30" with 3" Dia. Column | 19 |
| T3636M | 36" x 36" with 4" Dia. Column | 32 |
| TR18M | 18" R with 3" Dia. Column | 23 |
| TR22M | 22" R with 4" Dia. Column | 45 |
| TR30M | 30" R with 4" Dia. Column | 57 |
| Bar Height 2-PC Easy Assembly Indoor & Outdoor Table Base Kits | | |
| T0522M-BAR | 5" x 22" with 3" Bar Height Column | 17 |
| T2222M-BAR | 22" x 22" with 3" Bar Height Column | 17 |
| T2230M-BAR | 22" x 30" with 3" Bar Height Column | 22 |
| T3030M-BAR | 30" x 30" with 3" Bar Height Column | 22 |
| T3636M-BAR | 36" x 36" with 4" Bar Height Column | 37 |
| TR18M-BAR | 18" R. with 3" Bar Height Column | 26 |
| TR22M-BAR | 22" R. with 4" Bar Height Column | 49 |
| TR30M-BAR | 30" R. with 4" Bar Height Column | 61 |
| Add-on Accessory | | |
| TF-3R | Indoor Table Base Foot Ring (3" Diameter) | 7 |
| TF-4R | Indoor Table Base Foot Ring (4" Diameter) | 9 |

Recommended 2-PC Base Size By Table Top Size

| Top Size | Recom. Base | Top Size | Recom. Base | Top Size | Recom. Base | Top Size | Recom. Base |
|-----------|----------------------------|----------------------------|-----------------------|----------------------------|---------------------------|--------------------------------|-----------------------|
| 24" Round | T2222M or TR18M | 30" Round | T2222M or TR22M | 36" Round | T3030M or TR22M | 42" Round | T3636M or TR30M |
| 24" x 24" | | 30" x 30" | | 36" x 36" | | 42" x 42" | |
| 24" x 30" | T2230M | 30" x 42" | T2230M or TR22M | 36" x 48" | T0522M (2) or TR22M | 48" Round | |
| 24" x 42" | T0522M (2) or T2230M | 30" x 45" | | | | | |
| 24" x 48" | | T0522M (2) or T2230M | 30" x 48" | T0522M (2) or T2230M | 30" x 60" | T2222M (2) or T2230M (2) | |
| 24" x 60" | 30" x 72" | | | | | | |

**Limited life time warranty for all table bases. Please contact us for more info

**Standard Base Height: 28 1/2", Bar Height: 40 1/4"

Table Base Parts

2-PC / 3-PC Table Base Parts

**Limited Life Time
Warranty
for All Table Bases**

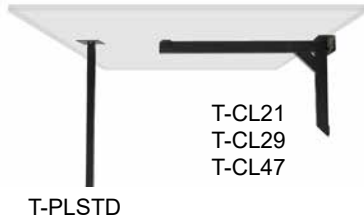

| Base & Column Prices | | |
|---|------------------|-----|
| Model # | Use Dia Size | lbs |
| Bottom Base Only for 2-PC / 3-PC Table Bases Kit | | |
| T0522-BB | 3" Diameter | 6 |
| T2222-BB | 3" Diameter | 9 |
| T2230-BB | 3" Diameter | 11 |
| T3030-BB | 3" Diameter | 12 |
| T3636-BB | 4" Diameter | 15 |
| TR18-BP | 3" Diameter | 16 |
| TR22-BP | 4" Diameter | 28 |
| TR30-BP | 4" Diameter | 44 |
| 2-PC Columns (Welded Spider Column, Bolt Set) | | |
| TC2503M | 3" Diameter | 7 |
| TC2504M | 4" Diameter | 10 |
| TC3703M-BAR | 3" Diameter | 9 |
| TC3704M-BAR | 4" Diameter | 14 |
| 3-PC Table Base Columns (Column, Bolt Set) | | |
| TC2503 | 3" Diameter | 5 |
| TC2504 | 4" Diameter | 8 |
| TC3703-BAR | 3" Diameter | 7 |
| TC3704-BAR | 4" Diameter | 12 |
| Spider for 3-PC Table Base | | |
| TC1315 | 3" & 4" Diameter | 2.8 |

| Case Pricing | | |
|--|----------|-----|
| Model # | Qty/Case | lbs |
| Bottom Base Only for 2-PC / 3-PC Table Bases | | |
| T0522-BB-CASE | 10 | 63 |
| T2222-BB-CASE | 5 | 47 |
| T2230-BB-CASE | 5 | 57 |
| T3030-BB-CASE | 5 | 62 |
| T3636-BB-CASE | 2 | 77 |
| TR18-BP-CASE | 5 | 83 |
| TR22-BP-CASE | 2 | 58 |
| 2-PC Columns (Welded Spider Column, Bolt Set) | | |
| TC2503M-CASE | 8 | 59 |
| TC2504M-CASE | 6 | 63 |
| TC3703M-BAR-CASE | 8 | 75 |
| TC3704M-BAR-CASE | 6 | 87 |
| 3-PC Table Base Columns (Column, Bolt Set) | | |
| TC2503-CASE | 10 | 53 |
| TC2504-CASE | 8 | 67 |
| TC3703-BAR-CASE | 10 | 73 |
| TC3704-BAR-CASE | 4 | 50 |
| Spider for 3-PC Table Base | | |
| T1315-CASE | 10 | 30 |



Table Levelers

| Model # | lbs |
|------------------------|------|
| GLIDE-AUTO (Hydraulic) | 0.5 |
| GLIDE-TBB (Adjustable) | 0.02 |

Cantilever Table Bases

| Model # | lbs |
|---------|-----|
| T-CL21 | 10 |
| T-CL29 | 11 |
| T-CL47 | 13 |
| T-PLSTD | 5 |

ATS MFG

Miscellaneous

Hardware & Parts

| Model # | Type | lbs |
|----------------|---|------|
| GLIDE-AUTO | Glide, hydraulic, self adjusting, for table base (price per pack of 4) | 1.00 |
| GLIDE-BTH | Glide, for booths and Trash Receptacle (price per each) (please specify model) | 0.02 |
| GLIDE-CBS-M | Glide, for metal chairs - SQUARE (price per each) (please specify model) | 0.02 |
| GLIDE-CBS-MO | Glide, for metal chairs - OVAL (price per each) (please specify model) | 0.02 |
| GLIDE-CBS-MR | Glide, for metal chairs - RECTANGULAR (price per each) (please specify model) | 0.02 |
| GLIDE-CBS-W | Glide, for wood chairs (price per pack of 4) (please specify model) | 0.02 |
| GLIDE-LGS | Metal Chair Leg Sleeve (price per each) (please specify model) | 0.05 |
| GLIDE-TBB | Glide, adjustable, for table base (price per each) | 0.02 |
| GLIDE-SRCF | Glide, for SR-CF | 0.02 |
| GLIDE-SRBF | Glide, for SR-BF | 0.02 |
| BRACKET-U-BLK | Bracket - Sydney U Black | 0.02 |
| BRACKET-U-BRE | Bracket - Sydney U Bronze | 0.02 |
| BRACKET-U-ZINC | Bracket - Sydney U Zinc | 0.02 |
| BRACKET-V-ZINC | Bracket - Sydney V Zinc (L) | 0.02 |
| FP-BRA | Brass Foot Plate | 0.11 |
| FP-CHM | Chrome Foot Plate | 0.11 |
| HDWE-MC | Hardware Pack, for metal chair | 0.40 |
| HDWE-WC | Hardware Pack, for wood chair | 0.43 |
| SCREW-B 3/4 | Screw, for ATE / ATP table tops (box of 50) | 0.30 |
| SCREW-Z 1/2 | Screw, 10 x 1/2 seat, zinc (box of 50) | 0.30 |
| SCREW-Z 3/4 | Screw, 10 x 3/4 seat, zinc (box of 50) | 0.30 |
| TR-DR-TOP | Trash Receptacle Top Door | 10 |
| TR-DR-BTM | Trash Receptacle Bottom Door | 10 |
| TR-DR-LATCH | Trash Receptacle Door Latch | 0.20 |
| TR-HINGE | Trash Receptacle Hinge | 0.06 |
| TR-RAIL | Trash Receptacle Rail Set | 1.00 |
| TR-LINER | Trash Receptacle Rigid Liner, 32 gallon capacity, plastic | 9.00 |
| Model # | Swivels | |
| SR-FLAT | Barstool flat swivel plate | 3.00 |
| SR-3DEG | Barstool Beveled 3' degree swivel plate | 3.00 |

Furniture Components

| Model # | Upholstery Description | lbs |
|-----------------|--|-------|
| CAPE-UPH-AD | Replacement Upholstered End Cap, for double booths | 2.00 |
| CAPE-UPH-AS | Replacement Upholstered End Cap, for single booths | 1.00 |
| CAPT-UPH-ASD | Replacement Upholstered Top Cap (price per linear foot) | 1.50 |
| SEAT-PAD-ASD-46 | Replacement Booth Seat Only , 46" long, for standard | 23.00 |
| SEAT-PAD-ASD | Replacement Booth Seat Only , Custom Length, Price Per FT | N/A |
| SEAT-CVR-ASD-46 | Replacement Booth Seat Cover Only , 46" long | 2.00 |
| SEAT-CVR-ASD | Replacement Booth Seat Cover Only , Custom Length, Price Per FT | N/A |
| SEAT-PAD-ACRN | Replacement Corner Booth Seat Only , Custom Length, Price Per FT | N/A |
| SEAT-CVR-ACRN | Replacement Corner Booth Seat Cover Only , Custom Length, Price Per FT | N/A |
| 5000 | Replacement Upholstered Seat, for metal chair, Custom (Add -GR4 , -GR5, -GR6 for respective vinyl grade model) | 4.50 |
| 5000-BLK | Replacement Black Vinyl Seat for metal chair | 4.50 |
| 5000-RD | Replacement Red Vinyl Seat for metal chair | 4.50 |
| VINYL-FABRIC | Vinyl/Fabric Only (fabric yard) | 2.00 |
| VINYL-KICK | Black Vinyl- Kickplate, (price per lineal foot) | 2.00 |
| Model # | Wood Cap Description | lbs |
| CAPE-WD-AD | Replacement Wood End Cap, double vinyl booth | 3.00 |
| CAPE-WD-AS | Replacement Wood End Cap, single vinyl booth | 2.00 |
| CAPT-WD-ASD | Replacement Wood Top Cap (price per linear foot) | 2.00 |
| Model # | Wood Components for Metal Chairs & Barstools | lbs |
| 77A-BACK | Replacement Veneer Back for 77A | 2.00 |
| 77B-BACK | Replacement Veneer Back for 77B | 2.00 |
| 77E-BACK | Replacement Veneer Back for 77E | 2.00 |
| 6000 | Replacement Veneer Seat for 77 Series | 3.50 |
| 7000 | Replacemt Solid Wood Seat for 77 Series | 5.00 |
| Model # | Wood Components for Wood Chairs & Barstools | lbs |
| SEAT-WC-VN | Replacement Veneer Seat for wood chair/barstool | 3.50 |
| SEAT-WC-WD | Replacment Solid Wood seat for wood chair/barstool | 5.00 |
| Model # | Vinyl Description | lbs |
| T-MOLD-BULL | Vinyl - Bullnose T-Mold (specify color) | 0.50 |
| T-MOLD | Vinyl - T-mold (specify color) | 0.20 |

Booths

Space Planning - Dimensions

ATS Single Upholstered Booth Upholstery Dimensions

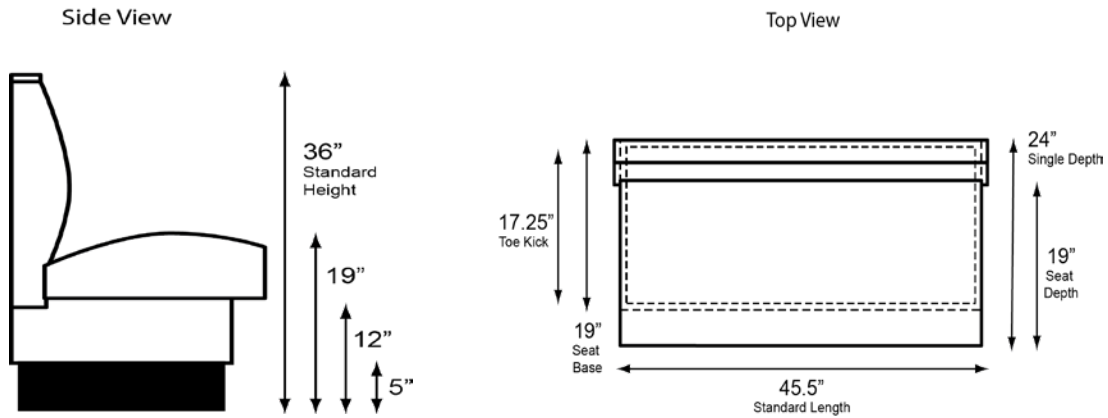

ATS Double Upholstered Booth Upholstery Dimensions

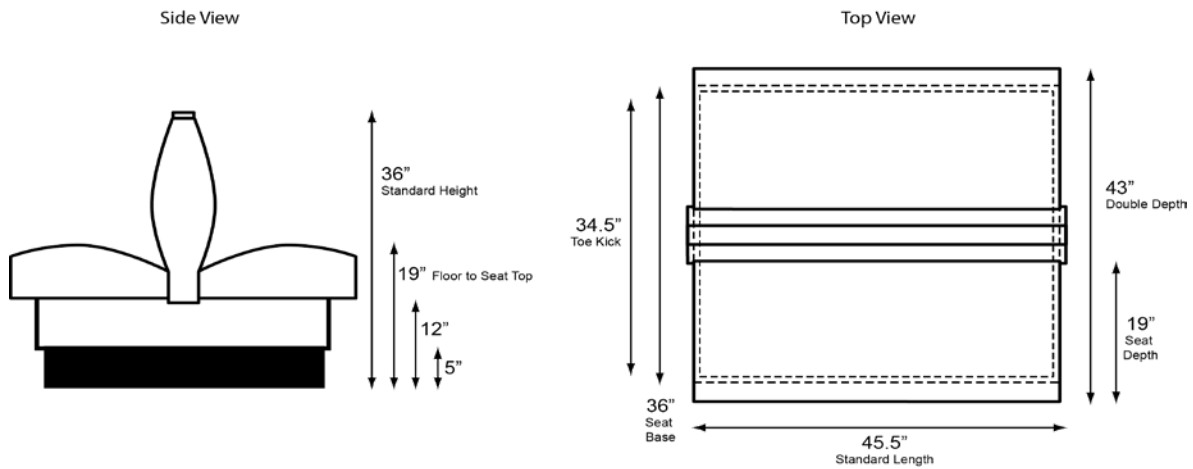

ATS Single Wood Booth Dimensions

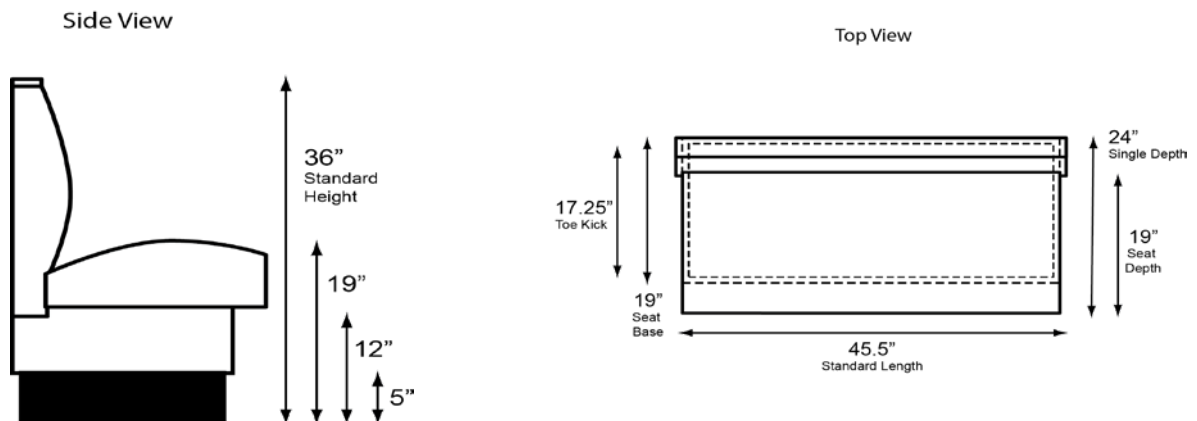



2024 Price List





FLO Faucets

Heavy Duty Pre-Rinse Faucet

Description

This pre-rinse faucet with sprayer is perfect for rinsing excess food and sauce off your dishes prior to running them through your commercial dish machine. Intended for janitorial and dishwashing use, this faucet is ideal for dish rooms, schools, grocery stores, kitchens, and more.

Features

- Approximately 45" overall height
- 3-Ply, 400 psi test hose
- Heavy duty brass construction and polished chrome finish
- Integrated spring check valves to prevent crossflow of hot & cold water
- 44" Standard hose



Lead Free Faucets
All faucets conform to AB 1953 and 2014 Federal Lead Free Standards.

| Item # | Description | Inlet Type | PCS/Case | lbs/Case |
|---------|----------------------|-----------------|----------|----------|
| FLO-988 | 8" Pre-Rinse Faucet | 1/2" NPT Female | 4 | 46.1 |
| FLO-981 | 12" Pre-Rinse Faucet | 1/2" NPT Female | 4 | 49.2 |

Optional Add-On:



Lead Free Faucets
All faucets conform to AB 1953 and 2014 Federal Lead Free Standards.

| Item # | Description | PCS/Case | lbs/Case |
|---------|-----------------------|----------|----------|
| FLO-944 | Faucet with 12" Spout | 12 | 25.6 |
| FLO-945 | Faucet with 14" Spout | 12 | 26.0 |

◇ Add-on Faucet sets available (See next page)

Heavy Duty Pre-Rinse Faucet Sets

Description

This pre-rinse faucet with sprayer is perfect for rinsing excess food and sauce off your dishes prior to running them through your commercial dish machine. Intended for janitorial and dishwashing use, this faucet is ideal for dish rooms, schools, grocery stores, kitchens, and more.

Features

- Approximately 45" overall height
- 3-Ply, 400 psi test hose
- Heavy duty brass construction and polished chrome finish
- Integrated spring check valves to prevent crossflow of hot & cold water
- 44" Standard hose
- Comes with additional spout



FLO-98812
FLO-98814



FLO-98112
FLO-98114

Lead Free Faucets

All faucets conform to AB 1953 and 2014 Federal Lead Free Standards.



| Item # | Description | Inlet Type |
|-----------|-------------------------------------|-----------------|
| FLO-98812 | 8" Pre-Rinse Faucet with 12" Spout | 1/2" NPT Female |
| FLO-98814 | 8" Pre-Rinse Faucet with 14" Spout | 1/2" NPT Female |
| FLO-98112 | 12" Pre-Rinse Faucet with 12" Spout | 1/2" NPT Female |
| FLO-98114 | 12" Pre-Rinse Faucet with 14" Spout | 1/2" NPT Female |

Wall Mount Faucet

Features

Commercial Duty Faucet

- Engineered for performance & durability
- Reinforced double O-ring valves with Hot & Cold mark on stem
- Heavy duty brass construction and polished chrome body
- Color coded Red & Blue handles
- Heavy duty double O-ring swivel spout

Lead Free Faucets
All faucets conform to AB 1953 and 2014 Federal Lead Free Standards.



FLO-700 series

| Item # | Description | PCS/Case | lbs/Case |
|---------|-------------------------------------|----------|----------|
| FLO-706 | Wall Mount Faucet 8" with 6" Spout | 12 | 36.8 |
| FLO-708 | Wall Mount Faucet 8" with 8" Spout | 12 | 36.4 |
| FLO-710 | Wall Mount Faucet 8" with 10" Spout | 12 | 34.2 |
| FLO-712 | Wall Mount Faucet 8" with 12" Spout | 12 | 35.3 |
| FLO-714 | Wall Mount Faucet 8" with 14" Spout | 12 | 41.0 |
| FLO-716 | Wall Mount Faucet 8" with 16" Spout | 12 | 42.8 |

Features

Heavy Duty Faucet

- Engineered for high performance & durability
- Integrated spring check valves to prevent cross-flow of Hot & Cold water
- Heavy duty brass construction and polished chrome body
- Color coded Red & Blue handles
- Heavy duty double O-ring swivel spout

Lead Free Faucets
All faucets conform to AB 1953 and 2014 Federal Lead Free Standards.



FLO-800 series

| Item # | Description | PCS/Case | lbs/Case |
|---------|-------------------------------------|----------|----------|
| FLO-808 | Wall Mount Faucet 8" with 8" Spout | 12 | 53.8 |
| FLO-810 | Wall Mount Faucet 8" with 10" Spout | 12 | 55.1 |
| FLO-812 | Wall Mount Faucet 8" with 12" Spout | 12 | 56.5 |
| FLO-814 | Wall Mount Faucet 8" with 14" Spout | 12 | 59.1 |
| FLO-816 | Wall Mount Faucet 8" with 16" Spout | 12 | 56.7 |

Replacement Parts:

| | Item # | Description | PCS/Case | lbs/Case |
|--|-----------|--|----------|----------|
| | FLO-700CF | Supply Inlet for FLO-7-Series | 12 | 53.8 |
| | FLO-890CF | Supply Inlet for FLO-8-Series | 12 | 55.1 |
| | FLO-700W | Rubber Washer for FLO-7-Series | 20 | 56.5 |
| | FLO-890W | Rubber Washer for FLO-8-Series | 20 | 59.1 |
| | FLO-4789D | Rear Pipe Nipple Washer & Lock Nut Set | 20 | 56.7 |
| | FLO-4789W | Mounting Kit for FLO 7- & 8-Series | 20 | 14.0 |

4" Wall / Deck Mount Faucet

Features

4" Wall Mount Faucet for Hand Sink

- Engineered for high performance & durability
- Reinforced double O-ring valves with hot & cold marked on stem
- Compression nuts & washers attached
- Color coded red & blue handles
- Heavy duty double O-ring swivel spout
- 1/2" NPS male inlets
- Stem check unit replacement available



Lead Free Faucets

All faucets conform to AB 1953 and 2014 Federal Lead Free Standards.



FLO-410

| Item # | Description | PCS/Case | lbs/Case |
|----------|--|----------|----------|
| FLO-410 | 4" Wall Mount Faucet with 3-1/2" Gooseneck Spout | 24 | 58.0 |
| FLO-4105 | 4" Wall Mount Faucet with 5" Gooseneck Spout | 24 | 62.0 |

Features

4" Deck Mount Faucet for Bar Sink

- Engineered for high performance & durability
- Reinforced double O-ring valves with hot & cold marked on stem
- Compression nuts & washers attached
- Color coded red & blue handles
- Heavy duty double O-ring swivel spout
- 1/2" NPS male inlets
- Stem check unit replacement available



Lead Free Faucets







All faucets conform to AB 1953 and 2014 Federal Lead Free Standards.



FLO-420

| Item # | Description | PCS/Case | lbs/Case |
|----------|--|----------|----------|
| FLO-420 | 4" Deck Mount Faucet with 3-1/2" Gooseneck Spout | 24 | 58.0 |
| FLO-4205 | 4" Deck Mount Faucet with 5" Gooseneck Spout | 24 | 62.0 |

Replacement Parts:

| | Item # | Description | PCS/Case | lbs/Case |
|---|---------|--|----------|----------|
|  | FLO-122 | B-Handle, Cold, with Blue index | 20 | 3.0 |
|  | FLO-123 | B-Handle, Hot, with Red index | 20 | 3.0 |
|  | FLO-161 | Stem Assembly for 4-series, Cold | 20 | 6.0 |
|  | FLO-162 | Stem Assembly for 4-series, Hot | 20 | 6.0 |
|  | FLO-100 | Stem Check Unit with B-Handle for 7-Series | - | - |
|  | FLO-101 | Stem Check Unit with B-Handle for 7-Series | - | - |

Wall / Deck Mount Faucets

Features

4" Wall Mount Faucet for Hand Sink

- Engineered for high performance & durability
- Reinforced double O-ring valves with hot & cold marked on stem
- Compression nuts & washers attached
- Color coded red & blue handles
- Heavy duty double O-ring swivel spout
- 1/2" NPS male inlets
- Stem check unit replacement available



FLO-4106

| Item # | Description | PCS/Case | lbs/Case |
|----------|-------------------------------------|----------|----------|
| FLO-4106 | 4" Wall Mount Faucet with 6" Spout | 24 | 52.7 |
| FLO-4108 | 4" Wall Mount Faucet with 8" Spout | 12 | 28.0 |
| FLO-4110 | 4" Wall Mount Faucet with 10" Spout | 12 | 28.0 |
| FLO-4112 | 4" Wall Mount Faucet with 12" Spout | 12 | 30.4 |

Features

4" Deck Mount Faucet for Bar Sink

- Engineered for high performance & durability
- Reinforced double O-ring valves with hot & cold marked on stem
- Compression nuts & washers attached
- Color coded red & blue handles
- Heavy duty double O-ring swivel spout
- 1/2" NPS male inlets
- Stem check unit replacement available



FLO-4206

| Item # | Description | PCS/Case | lbs/Case |
|----------|-------------------------------------|----------|----------|
| FLO-4206 | 4" Deck Mount Faucet with 6" Spout | 24 | 45.4 |
| FLO-4208 | 4" Deck Mount Faucet with 8" Spout | 12 | 28.0 |
| FLO-4210 | 4" Deck Mount Faucet with 10" Spout | 12 | 28.0 |
| FLO-4212 | 4" Deck Mount Faucet with 12" Spout | 12 | 30.4 |

Handle Waste Valve with Strainer

Features

Lever Handle Waste Valve



FLO-302



Lead Free Faucets

All faucets conform to AB 1953 and 2014 Federal Lead Free Standards.

| Item # | Description | PCS/Case | lbs/Case |
|---------|---|----------|----------|
| FLO-302 | Lever Handle Waste Valve 3-1/2" Sink Opening, 2" Drain Outlet | 12 | 46.3 |

Features

Twist Handle Waste Valve



FLO-303





Lead Free Faucets

All faucets conform to AB 1953 and 2014 Federal Lead Free Standards.

| Item # | Description | PCS/Case | lbs/Case |
|---------|---|----------|----------|
| FLO-303 | Twist Handle Waste Valve 3-1/2" Sink Opening, 2" Drain Outlet | 12 | 44.1 |

Replacement Parts:

| | Item # | Description | PCS/Case | lbs/Case |
|---|-----------|--|----------|----------|
|  | FLO-300PT | 3-1/2" Rubber Seal Washer for FLO 3-series | 20 | 1.0 |
|  | FLO-305PT | Flat strainer for twist handle waste | 20 | 2.0 |

Operation Valve

Features

Foot Pedal Operation Valve

- Engineered for high performance & durability
- Rough chrome plated body
- Self closing valves
- Red & blue indexed brass pedals with polished chrome finish
- 1/2" NPT female inlets & 1/2" NPT female outlet
- Replacement for self-closing valve available



FLO-202

Lead Free Faucets

All faucets conform to AB 1953 and 2014 Federal Lead Free Standards.



| Item # | Description | PCS/Case | lbs/Case |
|---------|--|----------|----------|
| FLO-202 | Foot Pedal Operation Valve with Red & Blue index | 12 | 35.8 |

Features

Knee Action Operation Valve

- Engineered for high performance & durability
- Rough chrome plated body
- Self closing valves
- Red & blue indexed brass pedals with polished chrome finish
- 1/2" NPT female inlets & 1/2" NPT female outlet
- Replacement for self-closing valve available



FLO-203

Lead Free Faucets

All faucets conform to AB 1953 and 2014 Federal Lead Free Standards.



| Item # | Description | PCS/Case | lbs/Case |
|---------|---|----------|----------|
| FLO-203 | Knee Action Valve with Red & Blue index | 12 | 47.2 |

Replacement Parts:

| Item # | Description | PCS/Case | lbs/Case |
|---|--|----------|----------|
|  FLO-907 | Spray Valve Assembly, Lead free, for Knee and Foot Operated Valves | 20 | 6.0 |

Wok Range Faucet

Features

Automatic Wok Range Faucet with 14" Spout

- 3/8" or 1/2" NPT male inlet
- 14" Spout
- Automatic turns on when spout is swung over wok
- Lead free

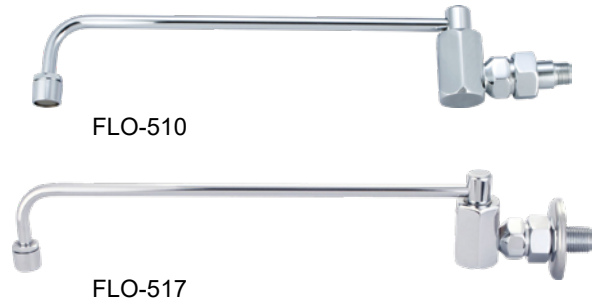

| Item # | Description | PCS/Case | lbs/Case |
|---------|---------------------------------------|----------|----------|
| FLO-510 | Automatic Wok Range Faucet 3/8" Inlet | 24 | 44.0 |
| FLO-517 | Automatic Wok Range Faucet 1/2" Inlet | 24 | 44.0 |

Replacement Parts:

| | Item # | Description | PCS/Case | lbs/Case |
|--|------------|---------------------------------------|----------|----------|
|  | FLO-5100PT | Replacement Kit for FLO-510 & FLO-517 | 10 | 2.0 |

Features



Chinese Wok Range Faucet with 14" Spout

- Single wall mount
- 14" Spout
- 2.0 GPM aerator 1/2" NPS male inlet
- Full replacement parts available
- Lead free

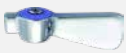

| Item # | Description | PCS/Case | lbs/Case |
|---------|---------------------------------|----------|----------|
| FLO-513 | Chinese Range Faucet 1/2" Inlet | 24 | 54.0 |

Replacement Parts:

| | Item # | Description | PCS/Case | lbs/Case |
|---|---------|---|----------|----------|
|  | FLO-122 | B-Handle, Cold, with Blue index | 20 | 1.0 |
|  | FLO-104 | Stem Check Unit with B-handle, for Chinese Wok Faucet | 20 | 2.0 |

Service Sink Faucet

Features

Service Sink Faucet with Support Bracket

- 8" center heavy duty quality
- Integrated spring check valves
- Built-in vacuum breaker
- 6-1/2" Spout with 3/4" hose thread
- Wall bracket with 12" rod
- 1/2" NPT female inlets
- Full replacement parts available

Lead Free Faucets





All faucets conform to AB 1953 and 2014 Federal Lead Free Standards.



FLO-840

| Item # | Description |
|---------|--|
| FLO-840 | Service Sink Faucet with Support Bracket |

Replacement Parts:

| | Item # | Description | PCS/Case | lbs/Case |
|---|-----------|---|----------|----------|
|  | FLO-102 | Stem Check Unit, with B-handle and blue index for heavy duty 8 & 9-Series | 20 | 11.0 |
|  | FLO-103 | Stem Check Unit, with B-handle and blue index for heavy duty 8 & 9-Series | 20 | 11.0 |
|  | FLO-122 | B-Handle, Cold with Blue index | 20 | 3.0 |
|  | FLO-123 | B-Handle, Hot with Red index | 20 | 3.0 |
|  | FLO-841PT | Vacuum Breaker Repair Kit | N/A | N/A |

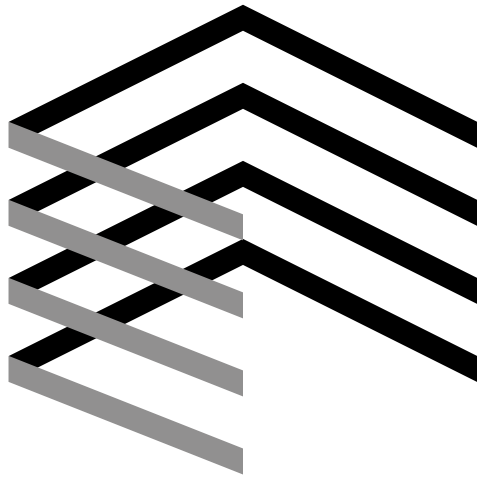

MET Stainless Steel

Wall Mount Hand Sinks

Description

- 6" height backsplash with 2" return
- 304 S/S sink top and bowl
- Z-clip mounting bracket included
- 4" wall mounted faucet and 1-1/2" drainer included
- NSF listed

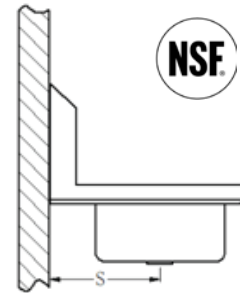
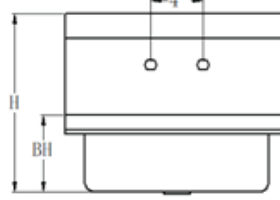
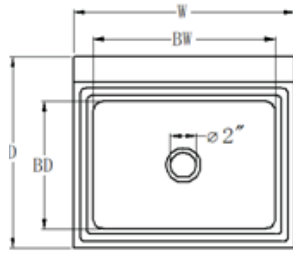

HS-1517S

| Item # | D x W x H | BD x BW x BH | S | Weight |
|----------|---------------------|------------------|--------|--------|
| HS-1512S | 15-3/4" x 12" x 14" | 9" x 9" x 3-3/4" | 8-1/2" | 7 lbs |
| HS-1517S | 15-3/4" x 17" x 14" | 10" x 14" x 6" | 8-1/2" | 13 lbs |

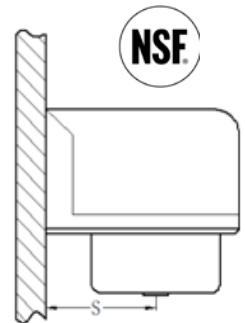
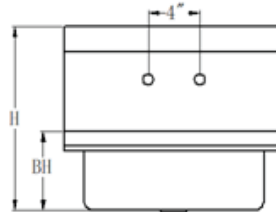
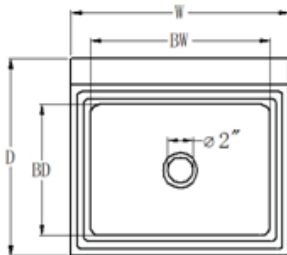

HS-1517BS

| Item # | D x W x H | BD x BW x BH | S | Weight |
|-----------|---------------------|------------------|--------|--------|
| HS-1512BS | 15-3/4" x 12" x 14" | 9" x 9" x 3-3/4" | 8-1/2" | 10 lbs |
| HS-1517BS | 15" x 17" x 14" | 10" x 14" x 6" | 8-1/2" | 16 lbs |

Compartment Sinks

1-Compartment

Description

- 11-1/2" height backsplash
- 304 S/S 16Ga. or 18 Ga. sink top and bowl
- 8" O.C. splash mount faucet hole
- 3-1/2" strainer hole, drain basket included
- Stainless steel legs with side cross bracing
- NSF listed

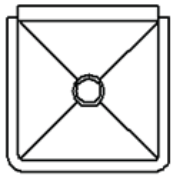
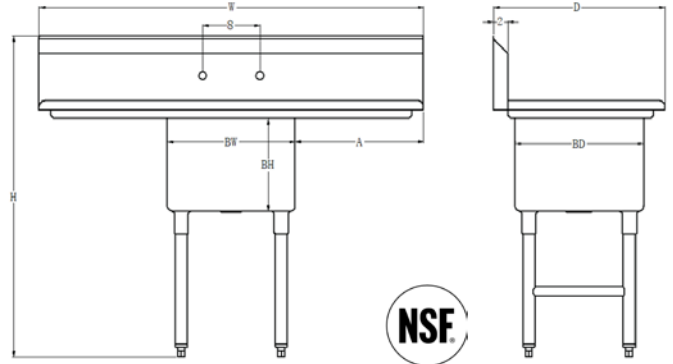

N
No Drain Board

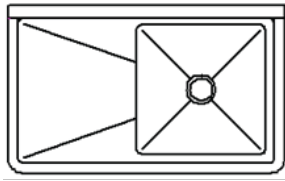

L
Left Drain Board

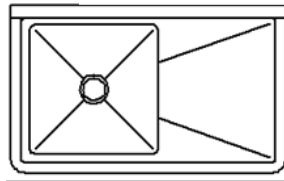

R
Right Drain Board

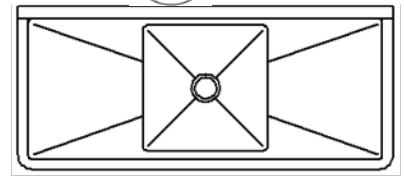

D
Left & Right Drain Board



| 1-Compartment Sink without Drain Board | | | | | |
|--|-----------------------------|-----------------|-------|--------|--|
| Item # | D x W x H | BD x BW x BH | Gauge | Weight | |
| SE-15151N | 18-5/8" x 18-1/4" x 43-7/8" | 15" x 15" x 13" | 18 | 27 lbs | |
| SE-18181N | 21-5/8" x 21-1/4" x 43-7/8" | 18" x 18" x 13" | 18 | 31 lbs | |
| SEH-20201N | 26" x 23-1/4" x 45" | 20" x 20" x 14" | 16 | 41 lbs | |
| SEH-24241N | 27-5/8" x 27-1/4" x 43-7/8" | 24" x 24" x 13" | 16 | 48 lbs | |



| 1-Compartment Sink with Left Drain Board | | | | | |
|--|-----------------|-----------------|-----|-------|--------|
| Item # | D x W x H | BD x BW x BH | A | Gauge | Weight |
| SE-15151L | 21" x 33" x 45" | 15" x 15" x 12" | 15" | 18 | 33 lbs |
| SE-18181L | 24" x 39" x 45" | 18" x 18" x 12" | 18" | 18 | 42 lbs |
| SEH-20201L | 26" x 43" x 45" | 20" x 20" x 14" | 20" | 16 | 56 lbs |
| SEH-24241L | 30" x 51" x 45" | 24" x 24" x 14" | 24" | 16 | 71 lbs |



| 1-Compartment Sink with Right Drain Board | | | | | |
|---|-----------------|-----------------|-----|-------|--------|
| Item # | D x W x H | BD x BW x BH | A | Gauge | Weight |
| SE-15151R | 21" x 33" x 45" | 15" x 15" x 12" | 15" | 18 | 33 lbs |
| SE-18181R | 24" x 39" x 45" | 18" x 18" x 12" | 18" | 18 | 42 lbs |
| SEH-20201R | 26" x 43" x 45" | 20" x 20" x 14" | 20" | 16 | 56 lbs |
| SEH-24241R | 30" x 51" x 45" | 24" x 24" x 14" | 24" | 16 | 71 lbs |



| 1-Compartment Sink with Left & Right Drain Board | | | | | |
|--|-----------------|-----------------|-----|-------|--------|
| Item # | D x W x H | BD x BW x BH | A | Gauge | Weight |
| SE-18181D | 24" x 54" x 45" | 18" x 18" x 12" | 18" | 18 | 52 lbs |
| SEH-24241D | 30" x 72" x 45" | 24" x 24" x 14" | 24" | 16 | 86 lbs |

Compartment Sinks

2-Compartment

Description

- 11-1/2" height backsplash
- 304 S/S 16Ga. or 18 Ga. sink top and bowl
- 8" OC splash mount faucet hole
- 3-1/2" strainer hole, drain basket included
- Stainless steel legs with side cross bracing
- NSF listed

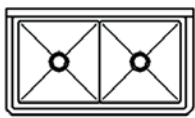
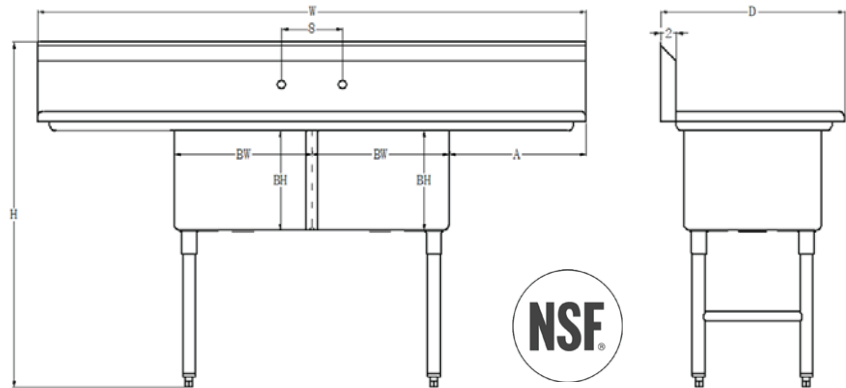

N
No Drain Board

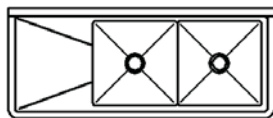

L
Left Drain Board

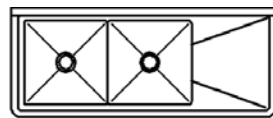

R
Right Drain Board

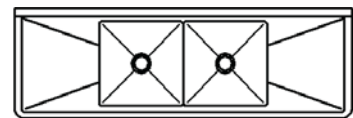

D
Left & Right Drain Board



2-Compartment Sink without Drain Board

| Item # | D x W x H | BD x BW x BH | Gauge | Weight |
|------------|-----------------|-----------------|-------|--------|
| SE-18182N | 24" x 42" x 45" | 18" x 18" x 12" | 18 | 55 lbs |
| SEH-24242N | 30" x 54" x 45" | 24" x 24" x 12" | 16 | 96 lbs |



2-Compartment Sink with Left Drain Board

| Item # | D x W x H | BD x BW x BH | A | Gauge | Weight |
|------------|-----------------|-----------------|-----|-------|---------|
| SE-18182L | 24" x 57" x 45" | 18" x 18" x 12" | 18" | 18 | 62 lbs |
| SEH-24242L | 30" x 75" x 45" | 24" x 24" x 14" | 24" | 16 | 110 lbs |



2-Compartment Sink with Right Drain Board

| Item # | D x W x H | BD x BW x BH | A | Gauge | Weight |
|------------|-----------------|-----------------|-----|-------|---------|
| SE-18182R | 24" x 57" x 45" | 18" x 18" x 12" | 18" | 18 | 62 lbs |
| SEH-24242R | 30" x 75" x 45" | 24" x 24" x 14" | 24" | 16 | 110 lbs |



2-Compartment Sink with Left & Right Drain Board

| Item # | D x W x H | BD x BW x BH | A | Gauge | Weight |
|------------|-----------------|-----------------|-----|-------|---------|
| SE-18182D | 24" x 72" x 45" | 18" x 18" x 12" | 18" | 18 | 69 lbs |
| SEH-24242D | 30" x 96" x 45" | 24" x 24" x 14" | 24" | 16 | 125 lbs |

Compartment Sinks

3-Compartment

Description

- 11-1/2" height backsplash
- 304 S/S 16Ga. or 18 Ga. sink top and bowl
- 8" OC splash mount faucet hole
- 3-1/2" strainer hole, drain basket included
- Stainless steel legs with side cross bracing
- NSF listed

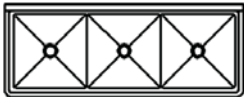
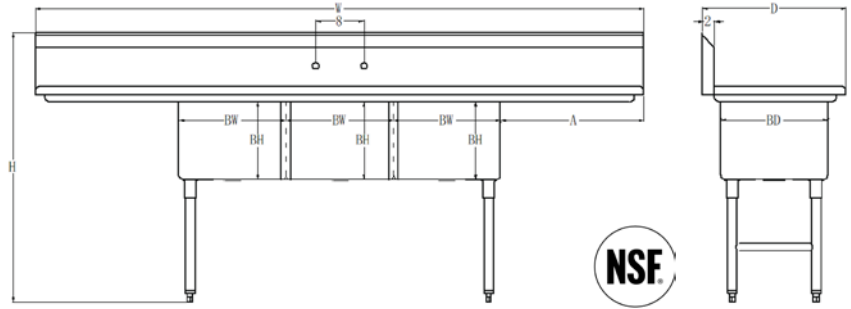

N
No Drain Board

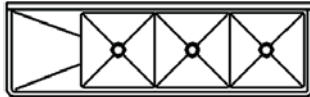

L
Left Drain Board

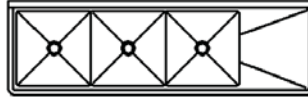

R
Right Drain Board

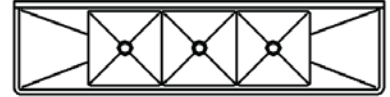

D
Left & Right Drain Board



3-Compartment Sink without Drain Board

| Item # | D x W x H | BD x BW x BH | Gauge | Weight |
|------------|-----------------|-----------------|-------|---------|
| SE-18183N | 24" x 60" x 45" | 18" x 18" x 12" | 18 | 74 lbs |
| SEH-24243N | 30" x 78" x 45" | 24" x 24" x 12" | 18 | 134 lbs |



3-Compartment Sink with Left Drain Board

| Item # | D x W x H | BD x BW x BH | A | Gauge | Weight |
|------------|-----------------|-----------------|-----|-------|---------|
| SE-15153L | 21" x 36" x 45" | 15" x 15" x 12" | 15" | 18 | 68 lbs |
| SE-18183L | 24" x 75" x 45" | 18" x 18" x 12" | 18" | 18 | 82 lbs |
| SEH-24243L | 30" x 99" x 45" | 24" x 24" x 14" | 24" | 16 | 149 lbs |



3-Compartment Sink with Right Drain Board

| Item # | D x W x H | BD x BW x BH | A | Gauge | Weight |
|------------|-----------------|-----------------|-----|-------|---------|
| SE-15153R | 21" x 36" x 45" | 15" x 15" x 12" | 15" | 18 | 68 lbs |
| SE-18183R | 24" x 75" x 45" | 18" x 18" x 12" | 18" | 18 | 82 lbs |
| SEH-24243R | 30" x 99" x 45" | 24" x 24" x 14" | 24" | 16 | 149 lbs |



3-Compartment Sink with Left & Right Drain Board

| Item # | D x W x H | BD x BW x BH | A | Gauge | Weight |
|-------------|------------------|-----------------|-----|-------|---------|
| SE-15153D | 21" x 75" x 45" | 15" x 15" x 12" | 15" | 18 | 74 lbs |
| SE-18183D | 24" x 90" x 45" | 18" x 18" x 12" | 18" | 18 | 90 lbs |
| SE-18183D24 | 24" x 102" x 45" | 18" x 18" x 12" | 24" | 18 | 96 lbs |
| SE-16203D18 | 26" x 84" x 45" | 20" x 16" x 12" | 18" | 18 | 90 lbs |
| SE-16203D24 | 26" x 96" x 45" | 20" x 16" x 12" | 24" | 18 | 96 lbs |
| SEH-20203D | 26" x 100" x 45" | 20" x 20" x 14" | 18" | 16 | 132 lbs |
| SEH-24243D | 30" x 120" x 45" | 24" x 24" x 14" | 24" | 16 | 164 lbs |

Compartment Sinks

4-Compartment Sink

Description

- 11-1/2" height backsplash
- 304 S/S 16Ga. or 18 Ga. sink top and bowl
- 8" OC splash mount faucet hole
- 3-1/2" strainer hole, drain basket included
- Stainless steel legs with side cross bracing
- NSF listed

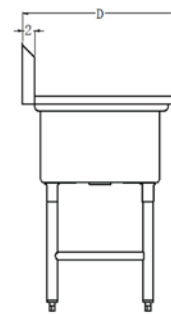
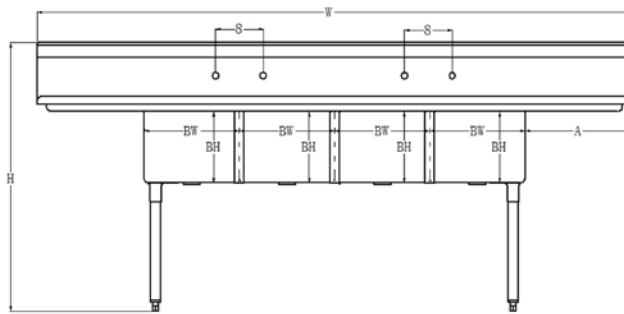

4-Compartment Sink with Left & Right Drain Board

| Item # | D x W x H | BD x BW x BH | A | Gauge | Weight |
|-------------|------------------|-----------------|-----|-------|---------|
| SE-16204D18 | 26" x 100" x 45" | 20" x 16" x 12" | 18" | 18 | 109 lbs |

Prep Table with Sink



- 304 S/S 18 Ga. table top and sink bowl
- 6" backsplash
- 4" OC deck mount faucet hole
- 3-1/2" strainer hole, strainer included
- Stainless steel under shelf
- Adjustable S/S bullet feet
- NSF listed

Prep Table with Sink

| Item # | D x W x H | Sink Bowl | Weight |
|------------|-----------------|-----------|---------|
| WTPS-3048L | 30" x 48" x 35" | Left | 81 lbs |
| WTPS-3048R | 30" x 48" x 35" | Right | 81 lbs |
| WTPS-3060L | 30" x 60" x 35" | Left | 94 lbs |
| WTPS-3060R | 30" x 60" x 35" | Right | 94 lbs |
| WTPS-3072L | 30" x 72" x 35" | Left | 106 lbs |
| WTPS-3072R | 30" x 72" x 35" | Right | 106 lbs |

Dish Tables

Clean Dish Tables

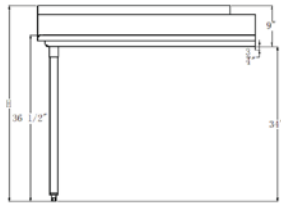
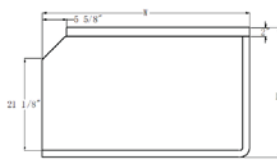
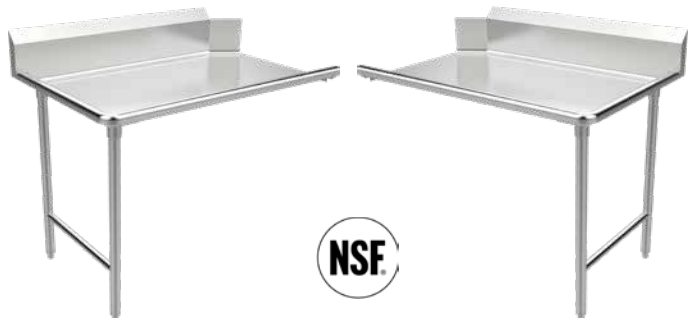

L
Left Side Model

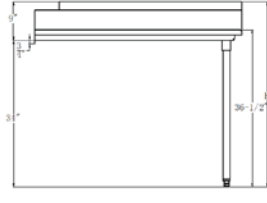

R
Right Side Model

- 9" height backsplash
- 304 S/S 16 Ga. table top
- Stainless steel legs with side cross bracing
- NSF listed

| Item # | D x W x H | Weight |
|---------|-----------------|--------|
| CDT-24L | 30" x 24" x 43" | 30 lbs |
| CDT-24R | 30" x 24" x 43" | 30 lbs |
| CDT-30L | 30" x 30" x 43" | 34 lbs |
| CDT-30R | 30" x 30" x 43" | 34 lbs |
| CDT-36L | 30" x 36" x 43" | 38 lbs |
| CDT-36R | 30" x 36" x 43" | 38 lbs |
| CDT-48L | 30" x 48" x 43" | 50 lbs |
| CDT-48R | 30" x 48" x 43" | 50 lbs |
| CDT-60L | 30" x 60" x 43" | 60 lbs |
| CDT-60R | 30" x 60" x 43" | 60 lbs |
| CDT-72L | 30" x 72" x 43" | 68 lbs |
| CDT-72R | 30" x 72" x 43" | 68 lbs |

Soiled Dish Tables

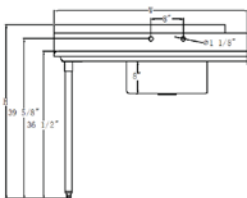
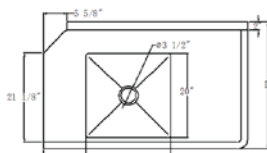
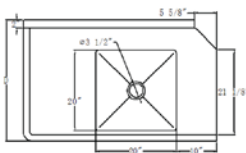

L
Left Side Model

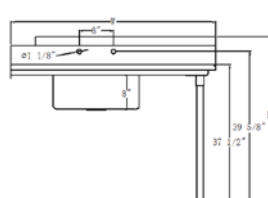

R
Right Side Model

- 9" height backsplash
- 304 S/S 16 Ga. table top and sink bowl
- 20"L x 20"W x 8"H bowl size
- 8"OC splash mount faucet hole
- 3-1/2" strainer hole, strainer included
- Stainless steel legs with side cross bracing
- NSF listed

| Item # | D x W x H | Weight |
|---------|-----------------|--------|
| SDT-30L | 30" x 30" x 43" | 48 lbs |
| SDT-30R | 30" x 30" x 43" | 48 lbs |
| SDT-36L | 30" x 36" x 43" | 53 lbs |
| SDT-36R | 30" x 36" x 43" | 53 lbs |
| SDT-48L | 30" x 48" x 43" | 57 lbs |
| SDT-48R | 30" x 48" x 43" | 57 lbs |
| SDT-60L | 30" x 60" x 43" | 69 lbs |
| SDT-60R | 30" x 60" x 43" | 69 lbs |
| SDT-72L | 30" x 72" x 43" | 79 lbs |
| SDT-72R | 30" x 72" x 43" | 79 lbs |

Work Tables

Economy Work Tables - 18 Ga.

- 430 S/S 18 Ga. table top
- 18 Ga. galvanized undershelf
- Table top reinforced with hat channel
- Galvanized legs with adjustable plastic bullet feet
- All work table uses 4 legs
- Shipped knocked-down in a box
- NSF listed

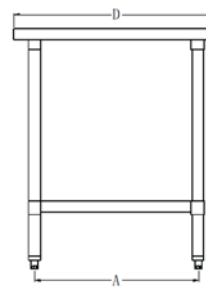

18 Ga. Economy Work Table 403 S/S top with Galvanized Undershelf

| Item # | D x W x H | A | B | Weight |
|----------|-----------------|-----|---------|--------|
| WTE-2424 | 24" x 24" x 35" | 18" | 17-1/8" | 34 lbs |
| WTE-2430 | 24" x 30" x 35" | 18" | 23-3/8" | 39 lbs |
| WTE-2436 | 24" x 36" x 35" | 18" | 29-3/8" | 45 lbs |
| WTE-2448 | 24" x 48" x 35" | 18" | 41-3/8" | 53 lbs |
| WTE-2460 | 24" x 60" x 35" | 18" | 53-3/8" | 63 lbs |
| WTE-2472 | 24" x 72" x 35" | 18" | 65-3/8" | 79 lbs |
| WTE-3012 | 30" x 12" x 35" | 24" | 7-1/8" | 24 lbs |
| WTE-3015 | 30" x 15" x 35" | 24" | 10-1/8" | 28 lbs |
| WTE-3018 | 30" x 18" x 35" | 24" | 13-1/8" | 34 lbs |
| WTE-3030 | 30" x 30" x 35" | 24" | 23-3/8" | 46 lbs |
| WTE-3036 | 30" x 36" x 35" | 24" | 29-3/8" | 54 lbs |
| WTE-3048 | 30" x 48" x 35" | 24" | 41-3/8" | 65 lbs |
| WTE-3060 | 30" x 60" x 35" | 24" | 53-3/8" | 79 lbs |
| WTE-3072 | 30" x 72" x 35" | 24" | 65-3/8" | 34 lbs |

Work Tables - Heavy Duty

| Item # | D x W x H | A | Weight |
|----------|-----------------|-----|---------|
| WTH-2430 | 24" x 30" x 35" | 18" | 42 lbs |
| WTH-2436 | 24" x 36" x 35" | 18" | 48 lbs |
| WTH-2448 | 24" x 48" x 35" | 18" | 58 lbs |
| WTH-2460 | 24" x 60" x 35" | 18" | 69 lbs |
| WTH-2472 | 24" x 72" x 35" | 18" | 86 lbs |
| WTH-2496 | 24" x 96" x 35" | 18" | 110 lbs |
| WTH-3024 | 30" x 24" x 35" | 24" | 42 lbs |
| WTH-3030 | 30" x 30" x 35" | 24" | 50 lbs |
| WTH-3036 | 30" x 36" x 35" | 24" | 57 lbs |
| WTH-3048 | 30" x 48" x 35" | 24" | 70 lbs |
| WTH-3060 | 30" x 60" x 35" | 24" | 83 lbs |
| WTH-3072 | 30" x 72" x 35" | 24" | 105 lbs |
| WTH-3096 | 30" x 96" x 35" | 24" | 141 lbs |

- 304 S/S 16 Ga. table top
- 430 S/S 18 Ga. undershelf
- Table top reinforced with hat channel
- S/S legs with adjustable S/S bullet feet
- Work table 72" & over in length uses 6 legs
- Shipped knocked-down in a box
- NSF listed



Work Tables - 18 Ga.

- 430 S/S 18 Ga. table top & undershelf
- Table top reinforced with hat channel
- S/S legs with adjustable S/S bullet feet
- Work table 72" & over in length uses 6 legs
- Shipped knocked-down in a box
- NSF listed

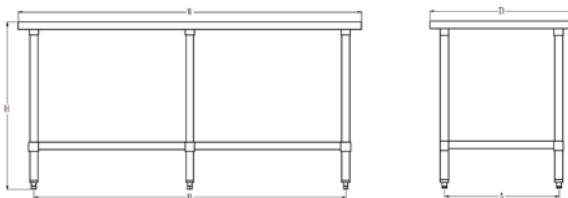

| Item # | D x W x H | A | Weight |
|---------|-----------------|-----|---------|
| WT-2412 | 24" x 12" x 35" | 18" | 22 lbs |
| WT-2415 | 24" x 15" x 35" | 18" | 25 lbs |
| WT-2418 | 24" x 18" x 35" | 18" | 29 lbs |
| WT-2424 | 24" x 24" x 35" | 18" | 34 lbs |
| WT-2430 | 24" x 30" x 35" | 18" | 39 lbs |
| WT-2436 | 24" x 36" x 35" | 18" | 45 lbs |
| WT-2448 | 24" x 48" x 35" | 18" | 53 lbs |
| WT-2460 | 24" x 60" x 35" | 18" | 63 lbs |
| WT-2472 | 24" x 72" x 35" | 18" | 79 lbs |
| WT-2496 | 24" x 96" x 35" | 18" | 96 lbs |
| WT-3012 | 30" x 12" x 35" | 24" | 24 lbs |
| WT-3015 | 30" x 15" x 35" | 24" | 28 lbs |
| WT-3018 | 30" x 18" x 35" | 24" | 34 lbs |
| WT-3024 | 30" x 24" x 35" | 24" | 38 lbs |
| WT-3030 | 30" x 30" x 35" | 24" | 46 lbs |
| WT-3036 | 30" x 36" x 35" | 24" | 54 lbs |
| WT-3048 | 30" x 48" x 35" | 24" | 65 lbs |
| WT-3060 | 30" x 60" x 35" | 24" | 79 lbs |
| WT-3072 | 30" x 72" x 35" | 24" | 98 lbs |
| WT-3084 | 30" x 84" x 35" | 24" | 116 lbs |
| WT-3096 | 30" x 96" x 35" | 24" | 130 lbs |

Work Tables with Backsplash

- 304 S/S 16 Ga. table top
- 430 S/S 18 Ga. undershelf
- 5" backspalsh
- Table top reinforced with hat channel
- S/S legs with adjustable S/S bullet feet
- Work table 72" & over in length uses 6 legs
- Shipped knocked-down in a box
- NSF listed

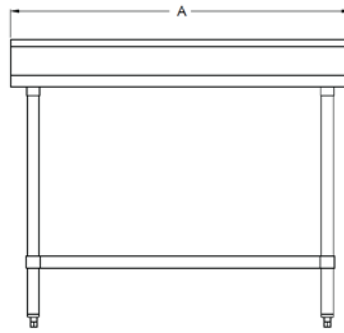

Front View

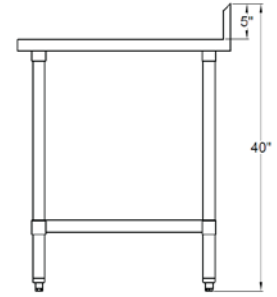

Side View



Work Table with 5" Backsplash

| Item # | D x W x H | A | Weight |
|-----------|-----------------|-----|---------|
| WTHB-3024 | 30" x 24" x 43" | 24" | 47 lbs |
| WTHB-3036 | 30" x 36" x 43" | 36" | 58 lbs |
| WTHB-3048 | 30" x 48" x 43" | 48" | 73 lbs |
| WTHB-3060 | 30" x 60" x 43" | 60" | 89 lbs |
| WTHB-3072 | 30" x 72" x 43" | 72" | 109 lbs |
| WTHB-3096 | 30" x 96" x 43" | 96" | 145 lbs |

S/S Work Table Undershef

- 430 S/S 18 Ga. undershef
- Fits MET WTHB, WTH, WT series work table
- NSF listed



WT-US2472
WT-US3072
WT-US3096

| Item # | D x W x H | Fit Table Size | Weight |
|-----------|------------------------|----------------|--------|
| WT-US2430 | 19-4/5" x 25-1/3" x 2" | 24" x 30" | 10 lbs |
| WT-US2436 | 19-4/5" x 31-1/3" x 2" | 24" x 36" | 12 lbs |
| WT-US2448 | 19-4/5" x 43-1/3" x 2" | 24" x 48" | 16 lbs |
| WT-US2460 | 19-4/5" x 55-1/3" x 2" | 24" x 60" | 20 lbs |
| WT-US2472 | 19-4/5" x 67-1/3" x 2" | 24" x 72" | 25 lbs |
| WT-US3030 | 25-4/5" x 25-1/3" x 2" | 30" x 30" | 13 lbs |
| WT-US3036 | 25-4/5" x 31-1/3" x 2" | 30" x 36" | 15 lbs |
| WT-US3048 | 25-4/5" x 43-1/3" x 2" | 30" x 48" | 20 lbs |
| WT-US3060 | 25-4/5" x 55-1/3" x 2" | 30" x 60" | 25 lbs |
| WT-US3072 | 25-4/5" x 67-1/3" x 2" | 30" x 72" | 30 lbs |
| WT-US3096 | 25-4/5" x 91-1/3" x 2" | 30" x 96" | 46 lbs |

Equipment Stand

- 304 S/S 16 Ga. table top
- Table top is built 3-sided 1.5" turn up
- Table top is reinforced with hat channel
- S/S legs with adjustable S/S bullet feet
- Equipment stand with 60" & over in length uses 6 legs
- Shipped knocked-down in a box
- NSF listed

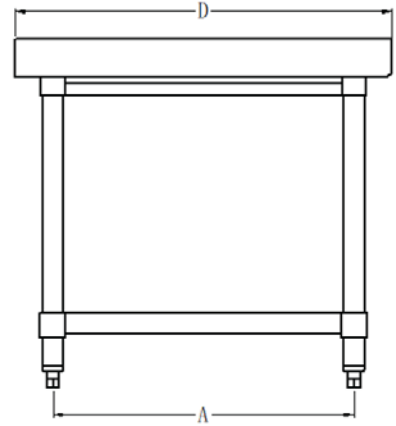
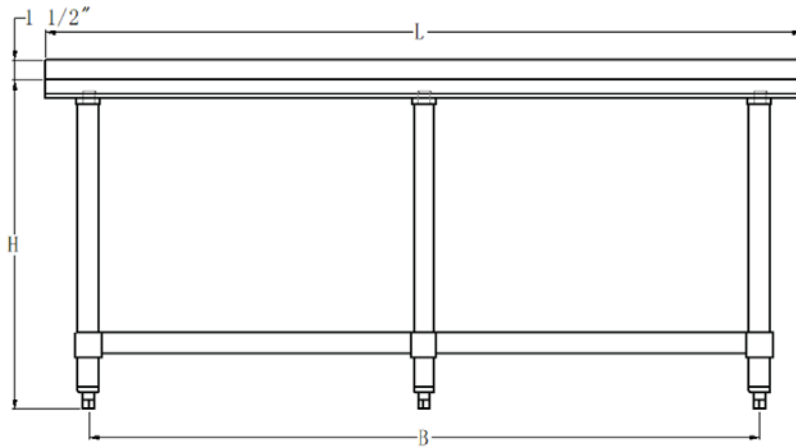

| 18 Ga. 430 S/S Equipment Stand | | | | |
|--------------------------------|-----------------|-----|--------|---------|
| Item # | D x W x H | A | B | Weight |
| ES-3012 | 30" x 12" x 26" | 24" | 7 | 27 lbs |
| ES-3018 | 30" x 18" x 26" | 24" | 13-1/3 | 35 lbs |
| ES-3024 | 30" x 24" x 26" | 24" | 17-1/2 | 40 lbs |
| ES-3036 | 30" x 36" x 26" | 24" | 29-1/2 | 52 lbs |
| ES-3048 | 30" x 48" x 26" | 24" | 41-1/2 | 68 lbs |
| ES-3060 | 30" x 60" x 26" | 24" | 53-1/2 | 88 lbs |
| ES-3072 | 30" x 72" x 26" | 24" | 65-1/2 | 101 lbs |



- For Vulcan Chip Warmer model VCW



| Portable Chip Warmer Stand | |
|----------------------------|--------|
| Item # | Weight |
| ES-27VCW | 43 lbs |

Rice Cooker Stand

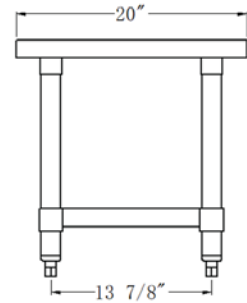
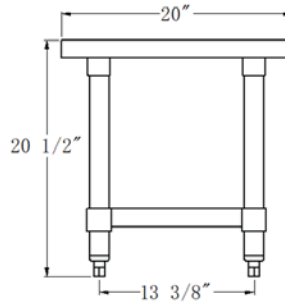
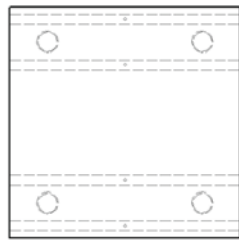

- 430 S/S 18 Ga. table top & undershelf
- Table top reinforced with hat channel
- S/S leg with adjustable S/S bullet feet
- Shipped knocked-down in a box
- NSF listed

| Rice Cooker Stand 18 Ga. 430 S/S | | |
|----------------------------------|---------------------|--------|
| Item # | D x W x H | Weight |
| ES-20 | 20" x 20" x 20-1/2" | 24 lbs |

Rice Warmer Cart

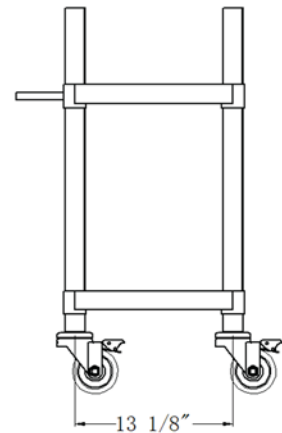
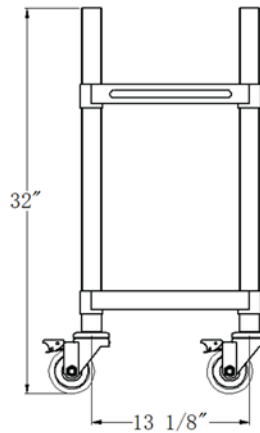
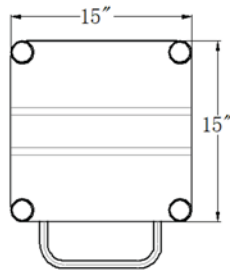

- 430 S/S 18 Ga. table top & undershelf
- S/S leg with 4" caster with break
- Shipped knocked-down in a box
- NSF listed

| Rice Warmer Cart 18 Ga. 430 S/S | | |
|---------------------------------|-----------------|--------|
| Item # | D x W x H | Weight |
| ES-15 | 15" x 15" x 32" | 29 lbs |

S/S Wall Shelves

- 430 S/S 18 Ga.
- S/S mounting brackets included
- Shipped knocked-down in a box
- Units with pot rack comes with double pot hooks
- NSF listed



S/S Wall Shelves

| Item # | D x W x H | Brackets | Weight |
|---------|--------------------|----------|--------|
| WS-1424 | 14" x 24" x 9-1/2" | 2 | 9 lbs |
| WS-1430 | 14" x 30" x 9-1/2" | 2 | 11 lbs |
| WS-1436 | 14" x 36" x 9-1/2" | 2 | 12 lbs |
| WS-1448 | 14" x 48" x 9-1/2" | 3 | 16 lbs |
| WS-1460 | 14" x 60" x 9-1/2" | 3 | 20 lbs |
| WS-1472 | 14" x 72" x 9-1/2" | 3 | 23 lbs |
| WS-1824 | 18" x 24" x 9-1/2" | 2 | 12 lbs |
| WS-1830 | 18" x 30" x 9-1/2" | 2 | 14 lbs |
| WS-1836 | 18" x 36" x 9-1/2" | 2 | 16 lbs |
| WS-1848 | 18" x 48" x 9-1/2" | 3 | 20 lbs |
| WS-1860 | 18" x 60" x 9-1/2" | 3 | 24 lbs |
| WS-1872 | 18" x 72" x 9-1/2" | 3 | 28 lbs |

S/S Wall Shelves with Pot Rack

| Item # | D x W | Brackets | Hooks |
|----------|-----------|----------|-------|
| WSP-1524 | 15" x 24" | 2 | 4 |
| WSP-1530 | 15" x 30" | 2 | 5 |
| WSP-1536 | 15" x 36" | 2 | 6 |
| WSP-1548 | 15" x 48" | 3 | 8 |
| WSP-1560 | 15" x 60" | 3 | 10 |
| WSP-1572 | 15" x 72" | 3 | 12 |
| WSP-1584 | 15" x 84" | 4 | 14 |
| WSP-1596 | 15" x 96" | 4 | 16 |

Microwave Oven Shelf

- 430 S/S 18 Ga. shelf
- S/S mounting brackets included
- Shipped knocked-down in a box
- NSF listed



| Item # | D x W x H | Brackets | Weight |
|---------|-----------------|----------|--------|
| MS-2418 | 18" x 24" x 14" | 2 | 14 lbs |

Slanted Wall Shelf

- 430 S/S 18 Ga. shelf
- S/S mounting brackets included
- Drain on the left
- Shipped knocked-down in a box
- NSF listed



| Item # | D x W x H | # of Brackets | Weight |
|---------|---------------------|---------------|--------|
| SW-2122 | 22" x 21" x 15-1/2" | 2 | 15 lbs |
| SW-4222 | 22" x 42" x 15-1/2" | 2 | 25 lbs |
| SW-6322 | 22" x 63" x 15-1/2" | 2 | 35 lbs |

S/S Double Overshelf

- 430 S/S 18 Ga. table top & undershelf
- S/S post, adjustable lower shelf
- L-shaped table mounting bracket
- Shipped knocked-down in a box
- NSF listed

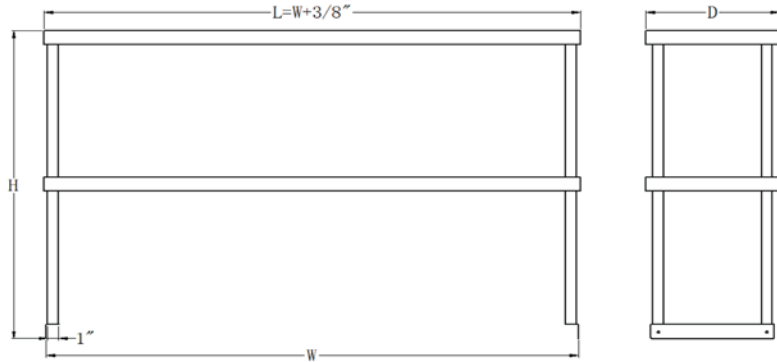

| Item # | D x W x H | Weight |
|----------|-----------------|--------|
| DOS-1436 | 14" x 36" x 32" | 30 lbs |
| DOS-1448 | 14" x 48" x 32" | 36 lbs |
| DOS-1460 | 14" x 60" x 32" | 41 lbs |
| DOS-1472 | 14" x 72" x 32" | 47 lbs |
| DOS-1836 | 18" x 36" x 32" | 35 lbs |
| DOS-1848 | 18" x 48" x 32" | 42 lbs |
| DOS-1860 | 18" x 60" x 32" | 49 lbs |
| DOS-1872 | 18" x 72" x 32" | 56 lbs |

S/S Cabinet

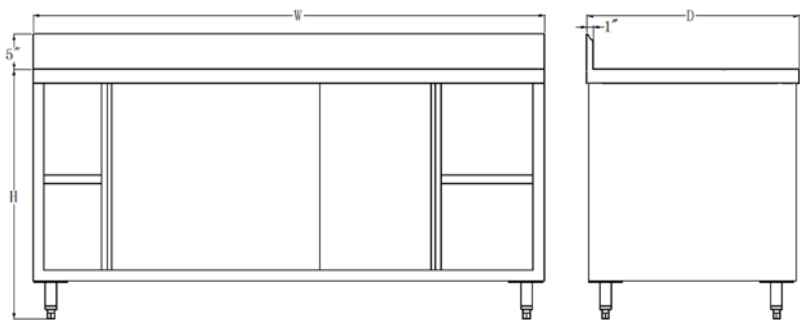

- 304 S/S 16 Ga. Top
- 430 S/S 18 Ga. body panels & shelf
- 5" backsplash
- Intermediate shelf & sliding doors
- Heavy duty adjustable S/S bullet feet
- Shipped knocked-down in a box
- NSF listed

| Item # | D x W x H | Weight |
|----------|-----------------|---------|
| CTD-3036 | 30" x 36" x 35" | 165 lbs |
| CTD-3048 | 30" x 48" x 35" | 204 lbs |
| CTD-3060 | 30" x 60" x 35" | 241 lbs |
| CTD-3072 | 30" x 72" x 35" | 279 lbs |

S/S Dish Cabinet

- 430 S/S 18 Ga. top
- 430 S/S 22 Ga. body panels & shelf
- Intermediate shelf
- Heavy duty adjustable S/S bullet feet
- Shipped knocked-down in a box
- NSF listed

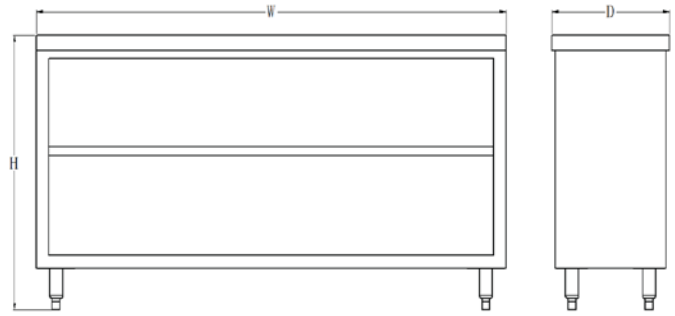

| Item # | D x W x H | Weight |
|----------|-----------------|--------|
| CDN-1536 | 15" x 36" x 35" | 57 lbs |
| CDN-1548 | 15" x 48" x 35" | 71 lbs |
| CDN-1560 | 15" x 60" x 35" | 83 lbs |
| CDN-1572 | 15" x 72" x 35" | 92 lbs |

Tubular Dish Drainage Shelf



- Wall mount drainage shelf
- Stainless steel construction
- Mounting bolts included
- NSF listed

| Item # | D x W | Weight | O.D. Tubing size |
|-----------|-----------|--------|------------------|
| TDDS-2415 | 15" x 24" | 12 lbs | 1-5/8" |
| TDDS-3615 | 15" x 36" | 16 lbs | |
| TDDS-4815 | 15" x 48" | 22 lbs | |
| TDDS-6015 | 15" x 60" | 30 lbs | |
| TDDS-7215 | 15" x 72" | 40 lbs | |

Beverage Table with Urn Troughs



- Built-in urn trough with drain
- 16 gauge stainless steel top
- 18 gauge stainless steel body
- 5" riser backsplash with standard electric outlet
- Stainless steel legs
- NSF listed

| Item # | D x W | Weight | # of adjustable shelf |
|----------|-----------|---------|-----------------------|
| BEV-3036 | 30" x 36" | 171 lbs | 1 |
| BEV-3048 | 30" x 48" | 211 lbs | 1 |
| BEV-3060 | 30" x 60" | 251 lbs | 1 |
| BEV-3072 | 30" x 72" | 291 lbs | 1 |

Pot Racks

Ceiling Mount Pot Racks

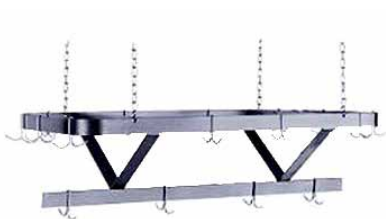

- Ceiling hung pot racks
- Triple bar design
- Stainless steel construction
- 24" plated hanging chains included
- NSF Listed

| Item # | D x W | Hooks |
|--------|-----------|-------|
| PRC-36 | 22" x 36" | 12 |
| PRC-48 | 22" x 48" | 14 |
| PRC-60 | 22" x 60" | 18 |
| PRC-72 | 22" x 72" | 22 |

Wall Mount Pot Racks

- Wall mount pot racks
- Double bar design
- Stainless steel construction
- NSF Listed



| Item # | D x W | Hooks |
|--------|-----------|-------|
| PRW-36 | 12" x 36" | 12 |
| PRW-48 | 12" x 48" | 14 |
| PRW-60 | 12" x 60" | 18 |
| PRW-72 | 12" x 72" | 22 |

Sinks

Dump Sink

- 304 S/S 20 Ga. sink top & bowl
- 430 S/S front & side panels
- 4" backsplash
- S/S legs with side cross bracing
- One compartment, no drain boards
- 4" wall mounted faucet & 1-1/2" drainer included
- NSF listed

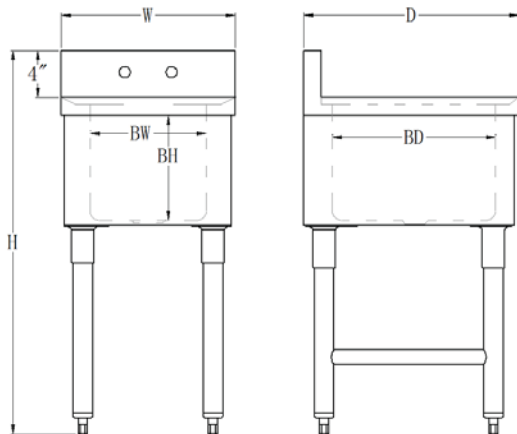

| Item # | D x W x H | # of Sink Bowl | # of Drain Board | BD x BW x BH | Weight |
|---------|---------------------|----------------|------------------|-----------------|--------|
| UBS-118 | 18-1/2" x 15" x 33" | 1 | 0 | 14" x 10" x 10" | 39 lbs |

Mop Sink

- 304 S/S 18 Ga. sink top & bowl
- 304 S/S 18 Ga. body panels
- NSF listed

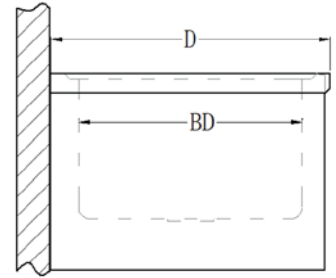
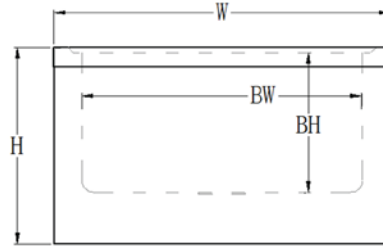

| Item # | D x W x H | BD x BW x BH | Weight |
|------------|-----------------|-----------------|--------|
| SEM-201610 | 20" x 24" x 14" | 16" x 20" x 10" | 30 lbs |
| SEM-202010 | 24" x 24" x 14" | 20" x 20" x 10" | 35 lbs |

Bar Sink

- 304 S/S 20 Ga. sink top & bowl
- 430 S/S front & side panels
- 4" backsplash
- 12" left & right drain boards (with drain board models)
- S/S legs with side cross bracing
- 4" wall mounted faucet & 1-1/2" drainer included
- NSF listed

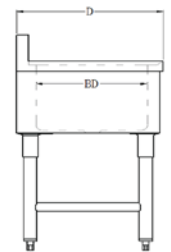
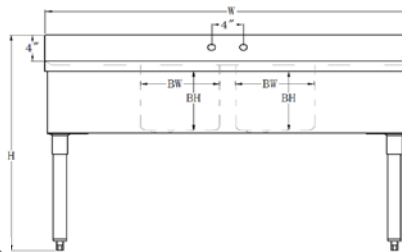

| Item # | D x W x H | # of Sink Bowl | # of Drain Board | BD x BW x BH | Weight |
|---------|---------------------|----------------|------------------|-----------------|--------|
| UBS-227 | 18-1/2" x 24" x 33" | 2 | 0 | 14" x 10" x 10" | 43 lbs |
| UBS-246 | 18-1/2" x 46" x 33" | 2 | 2 | 14" x 10" x 10" | 51 lbs |
| UBS-358 | 18-1/2" x 58" x 33" | 3 | 2 | 14" x 10" x 10" | 62 lbs |
| UBS-470 | 18-1/2" x 70" x 33" | 4 | 2 | 14" x 10" x 10" | 78 lbs |

Underbar

Ice Bin

- 304 S/S 18 Ga. sink top & bowl
- 430 S/S front & side panels
- 4" back splash
- Poly foam insulation
- S/S legs with side cross bracing
- NSF listed

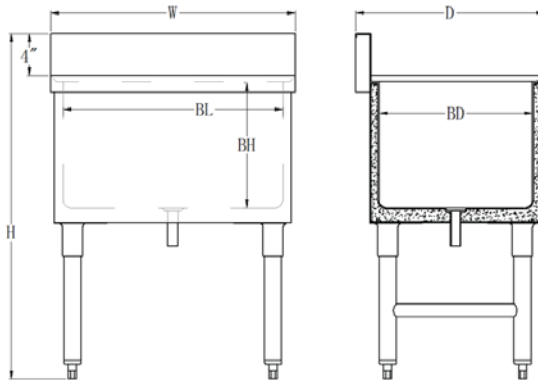

| Item # | D x W x H | BD x BW x BH | Weight |
|-----------|---------------------|-----------------|--------|
| UBIB-1824 | 18-1/2" x 24" x 33" | 15" x 21" x 12" | 48 lbs |
| UBIB-1830 | 18-1/2" x 30" x 33" | 15" x 27" x 12" | 55 lbs |
| UBIB-1836 | 18-1/2" x 36" x 33" | 15" x 33" x 12" | 65 lbs |
| UBIB-1848 | 18-1/2" x 48" x 33" | 15" x 45" x 12" | 79 lbs |

Ice Bin with Cold Plate

- 304 S/S construction
- S/S legs and sockets
- H shape weld leg bracing
- Approximately 96-98 lbs ice capacity
- 3" height back splash
- NSF listed

| Item # | D x W x H | Bowl Depth | Cold Plate |
|--------------|---------------------|------------|-----------------------|
| UBIB-247-CP | 18-1/2" x 24" x 30" | 12" | 7-circuit cold plate |
| UBIB-307-CP | 18-1/2" x 30" x 30" | 12" | |
| UBIB-367-CP | 18-1/2" x 36" x 30" | 12" | |
| UBIB-2410-CP | 18-1/2" x 24" x 30" | 12" | 10-circuit cold plate |
| UBIB-3010-CP | 18-1/2" x 30" x 30" | 12" | |
| UBIB-3610-CP | 18-1/2" x 36" x 30" | 12" | |



Ice Bin Covers



- Ice bin sliding cover
- 18/304 stainless steel construction
- NSF listed

| For Bins without Cold Plates | | | For Bins with Cold Plates | | |
|------------------------------|-------|-----------|---------------------------|-------|-----------------------------|
| Item # | Width | For Model | Item # | Width | For Model |
| IBSC-24 | 24" | UBIB-1824 | IBSC-24-CP | 24" | UBIB-247-CP UBIB-2410-CP |
| IBSC-30 | 30" | UBIB-1830 | IBSC-30-CP | 30" | UBIB-307-CP UBIB-3010-CP |
| IBSC-36 | 36" | UBIB-1836 | IBSC-36-CP | 36" | UBIB-367-CP UBIB-3610-CP |
| IBSC-48 | 48" | UBIB-1848 | | | |

Underbar Liquor Display

- 304 S/S 16 Ga. side panels
- 304 S/S 18 Ga. bottom & back panels
- 4" or 6" backsplash
- S/S legs with side cross bracing
- NSF listed



LQDR-1825
6" Backsplash



LQD-18

| Item # | D x W x H | Weight |
|-----------|---------------------|----------|
| LQD-12 | 21-1/8" x 12" x 33" | 30 lbs |
| LQD-18 | 21-1/8" x 18" x 33" | 35 lbs |
| LQD-24 | 21-1/8" x 24" x 33" | 41 lbs |
| LQD-30 | 21-1/8" x 30" x 33" | 48 lbs |
| LQD-36 | 21-1/8" x 36" x 33" | 52 lbs |
| LQDR-1825 | 25" x 18" x 30" | 35.5 lbs |
| LQDR-3025 | 25" x 30" x 30" | 47.1 lbs |
| LQDR-3625 | 25" x 36" x 30" | 53.1 lbs |

Glass Rack Station

- 304 S/S 20 Ga. sink top drain board
- 430 S/S body & side panels
- 4" backsplash
- Heavy duty adjustable S/S bullet feet
- NSF listed

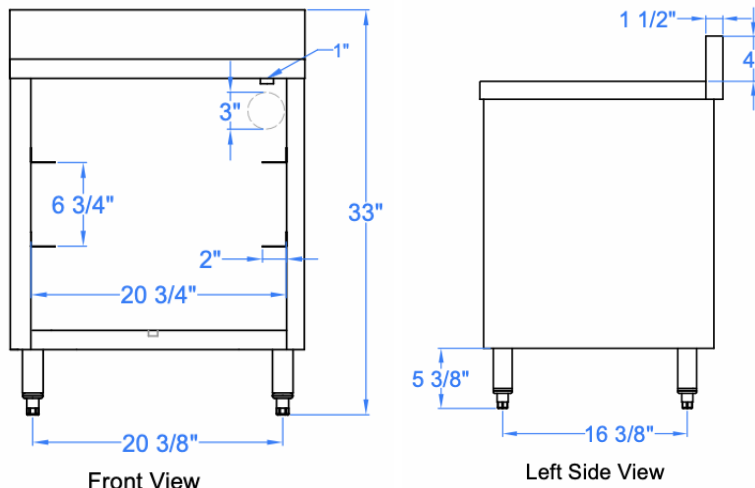

| Item # | D x W x H | Weight |
|----------|---------------------|----------|
| UBGR-242 | 21-1/8" x 12" x 33" | 50.9 lbs |
| UBGR-243 | 21-1/8" x 18" x 33" | 50.6 lbs |

Blender Station

- 304 S/S 20 Ga. sink top drain board
- 304 S/S body & side panels
- 4" backsplash
- Heavy duty adjustable S/S bullet feet
- 4" wall mounted faucet & 1-1/2" drainer included
- NSF listed

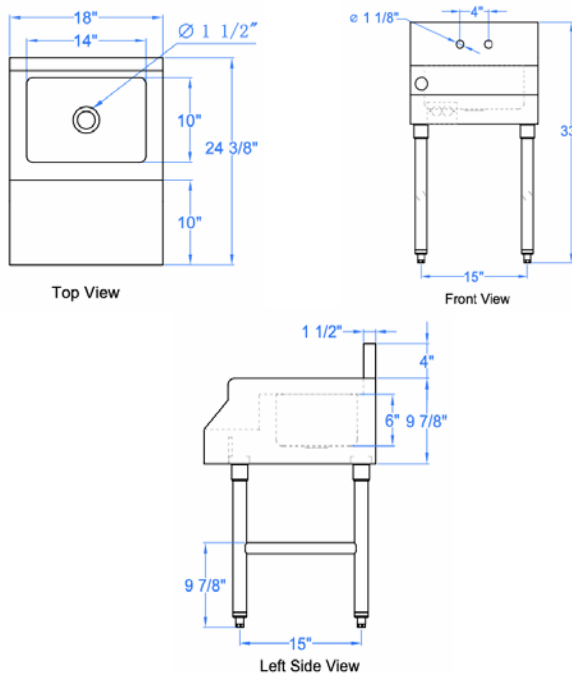

| Item # | D x W x H | BD x BW x BH | Weight |
|-----------|---------------------|----------------|--------|
| UBBS-1824 | 24-3/8" x 18" x 33" | 10" x 12" x 6" | 28 lbs |

Keg Racks



NSF

KRA-60

- 3 tier keg racks
- Rear straps can be purchased separately
- 1-5/16" dia. aluminum post

| Item # | D x W x H | # of Kegs |
|--------|-----------------|-----------|
| KRA-42 | 20" x 42" x 76" | 4 |
| KRA-60 | 20" x 60" x 76" | 6 |
| KRA-72 | 20" x 72" x 76" | 8 |

Aluminum Rear Straps for Keg Racks

| Item # | Description |
|---------|------------------|
| KRA-142 | For 42" Keg Rack |
| KRA-160 | For 60" Keg Rack |
| KRA-172 | For 72" Keg Rack |

Utility Carts



NSF

UBC-WS1836

- Wire utility cart
- 250 lbs capacity
- 3 shelves
- 4 swivel rubber casters with 2 brakes

| Item # | D x W x H |
|------------|-----------------|
| UBC-WS1836 | 18" x 36" x 38" |
| UBC-WS2142 | 21" x 42" x 33" |



NSF

UBC-1624SH

- 3 shelves utility cart
- 16 gauge angle legs
- 18 gauge 304 S/S construction
- All welded
- 350 lbs capacity

| Item # | D x W x H |
|------------|-------------------------|
| UBC-1624SH | 15-1/2" x 27" x 33-1/2" |
| UBC-1827SH | 18" x 27" x 34" |
| UBC-2135SH | 21" x 35" x 34" |

Green Shelf

- 850 lbs capacity for shelves shorter than 60"
- 600 lbs capacity for 60" & above shelves
- 74" height posts
- 2 shelves per box (minimum order per box)
- 4 posts per box (minimum order per box)

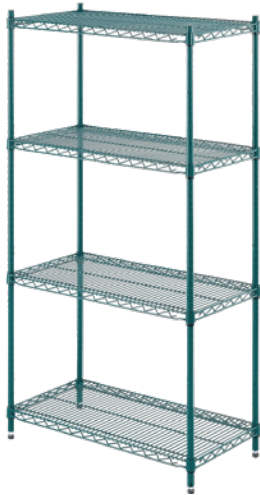

GS1436 & 4-tiers demo

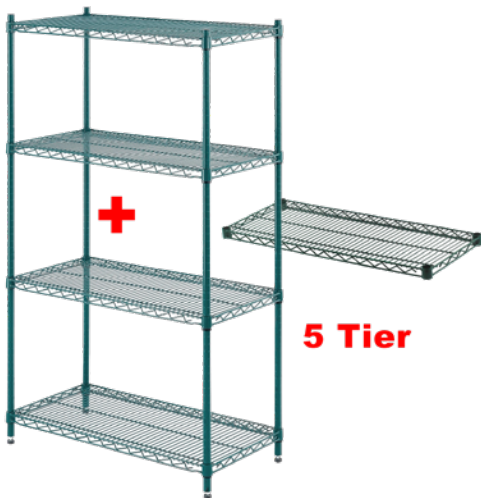

GS1436 & 5 tiers demo

| Item # | D x W |
|--------|---------------------|
| GS1424 | 14" x 24" |
| GS1436 | 14" x 36" |
| GS1448 | 14" x 48" |
| GS1460 | 14" x 60" |
| GS1824 | 18" x 24" |
| GS1830 | 18" x 30" |
| GS1836 | 18" x 36" |
| GS1848 | 18" x 48" |
| GS1860 | 18" x 60" |
| GS1872 | 18" x 72" |
| GS2436 | 24" x 36" |
| GS2448 | 24" x 48" |
| GS2460 | 24" x 60" |
| GS2472 | 24" x 72" |
| GSC074 | 74" H shelving post |

Bun Racks



BPR20



BPR-S20W (Stainless Steel, all welded)

- Open sides bun pan racks
- 3" spacing
- Welded angle slides
- 5" swivel casters
- Aluminum construction
- Ship knock-down
- NSF listed

| Item # | H x W x D | Pan Capacity & Size |
|----------|-------------------------|-----------------------------|
| BPR10 | 38-1/2" x 20-3/8" x 26" | (10) 18" x 26" |
| BPR20 | 65-1/2" x 20-3/8" x 26" | (20) 18" x 26" |
| BPR-S20W | 70-1/2" x 20-3/8" x 26" | (20) 18" x 26" (All welded) |

Hood Filters



F1620



- Dimension are in nominal
- Dish washer safe
- Built-in handles
- Stainless steel
- 6 each per box (minimum order per box)
- Fully interchangeable with existing filters
- NSF & UL certified



F2020

| Item # | H x W x D |
|--------|----------------|
| F1216 | 12" x 16" x 2" |
| F1616 | 16" x 16" x 2" |
| F1620 | 16" x 20" x 2" |
| F1625 | 16" x 25" x 2" |
| F2016 | 20" x 16" x 2" |
| F2020 | 20" x 20" x 2" |
| F2025 | 20" x 25" x 2" |



FT1721

(Fits all standard size exhaust hood filters)

| Hood Filter Tank | |
|------------------|-----------------|
| Item # | H x W x D |
| FT1721 | 34" x 17" x 21" |

Accessories

Work Table Accessories

- Heavy duty drawer for work table
- Ball bearing slides
- 200 lbs load capacity
- Stainless steel construction
- NSF listed



| Pre-Rinse Basket | | |
|------------------|-----------|----------|
| Item # | W x D | Capacity |
| DA-1818 | 18" x 18" | 200 lbs |

Fryer Accessories



- 430 S/S 22 Ga.

| Fryer Joiner Strip | | |
|--------------------|-------------------|---------|
| Item # | W x D x H | Weight |
| JSFF21 | 20-1/2" x 2" x 2" | 1 lbs |
| JSFF23 | 22-1/2" x 2" x 2" | 1 lbs |
| JSFF27 | 27" x 2" x 2" | 1.2 lbs |



| Fryer Basket Hanger | | |
|---------------------|-----------------------|-----------|
| Item # | W x D x H | Fryer |
| BH50 | 15-1/3" x 4-1/2" x 2" | 40-50 lbs |
| BH75 | 21" x 4-1/2" x 2" | 75 lbs |

S/S Baskets / Splash Guards

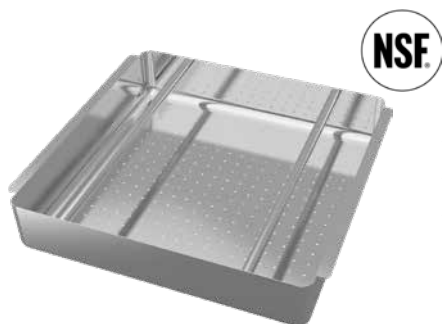

- 304 S/S 18 Ga.
- Perforated basket
- NSF listed

| Pre-Rinse Basket | | |
|------------------|--------------------|--------|
| Item # | For Sink Bowl Size | Weight |
| SDT-2020 | 20" x 20" | 12 lbs |



- 304 S/S 16 Ga.
- Perforated basket
- 3" deep basket
- NSF listed

| Prep Sink Basket | | |
|------------------|--------------------|---------|
| Item # | For Sink Bowl Size | Weight |
| PSB-1515 | 15" x 15" | 7 lbs |
| PSB-1620 | 16" x 20" | 9.5 lbs |
| PSB-1818 | 18" x 18" | 9.5 lbs |
| PSB-2020 | 20" x 20" | 11 lbs |
| PSB-2424 | 24" x 24" | 15 lbs |

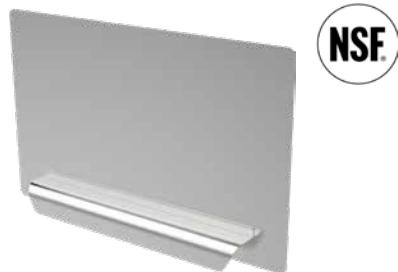

- 304 S/S 18 Ga.
- Welded bracket
- NSF listed

| Sink Splash Guards | | |
|--------------------|--------------------|--------|
| Item # | For Sink Bowl Size | Weight |
| SSG15 | 15" | 3 lbs |
| SSG18 | 18" | 4 lbs |
| SSG20 | 20" | 4 lbs |
| SSG24 | 24" | 5 lbs |



- 430 S/S 18 Ga.
- Welded bracket
- NSF listed

| Fryer Splash Guard | | |
|--------------------|-----------|--------|
| Item # | L x D | Weight |
| FSG2012 | 20" x 12" | 4 lbs |

Steam Table Pan & Cover



REPCF



REPF6



REPCF



REPQ6



REPS6

| Item # | Description |
|--------|------------------------------------|
| REPF1 | 1/1 steam table pan, 1.5" deep |
| REPF2 | 1/1 steam table pan, 2" deep |
| REPF4 | 1/1 steam table pan, 4" deep |
| REPF6 | 1/1 steam table pan, 6" deep |
| REPH2 | 1/2 steam table pan, 2" deep |
| REPH4 | 1/2 steam table pan, 2" deep |
| REPH6 | 1/2 steam table pan, 2" deep |
| REPN4 | 1/9 steam table pan, 4" deep |
| REPQ4 | 1/4 steam table pan, 6" deep |
| REPQ6 | 1/4 steam table pan, 6" deep |
| REPS2 | 1/6 steam table pan, 2" deep |
| REPS4 | 1/6 steam table pan, 4" deep |
| REPS6 | 1/6 steam table pan, 6" deep |
| REPT2 | 1/3 steam table pan, 2" deep |
| REPT4 | 1/3 steam table pan, 4" deep |
| REPT6 | 1/3 steam table pan, 6" deep |
| REPCF | 1/1 steam table pan cover, slotted |
| REPCH | 1/2 steam table pan cover, slotted |
| REPCN | 1/9 steam table pan cover, slotted |
| REPCS | 1/6 steam table pan cover, slotted |
| REPCT | 1/3 steam table pan cover, slotted |
| REPCF | 1/1 steam table pan cover, solid |
| REPSCH | 1/2 steam table pan cover, solid |
| REPCN | 1/9 steam table pan cover, solid |
| REPSCS | 1/6 steam table pan cover, solid |
| REPSCT | 1/3 steam table pan cover, solid |

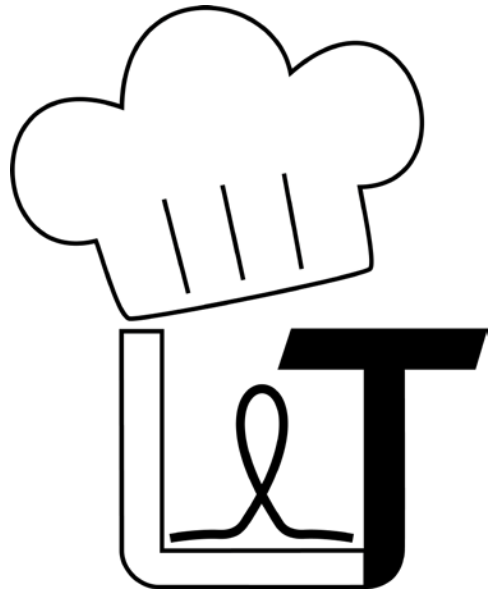

LIT

Wood Underliners



- USMRC
- 7-9/16" x 6"
- Rectangular
- Hand clean only
- Walnut Finished

Fits: Lodge HMSRC & HMS14RC



- UOJ13
- 15-1/2" L
- Oval
- Hand clean only
- Walnut Finished

Fits: Lodge LJOSH3



- UREC12
- 13-3/4" x 9-3/4"
- Rectangular
- Hand clean only
- Walnut Finished

Fits: Lodge LSCP3



- UOH10
- 11-3/4" L
- Oval, grip style
- Hand clean only
- Walnut Finished

Fits: Lodge LOS3 & LOSH3



- UR8
- 8" dia
- Round
- Hand clean only
- Walnut Finished

Fits: Lodge HMSRD, H3SK3, L3SK3



- UO10
- 11-3/4"L
- Oval
- Hand clean only
- Walnut Finished

Fits: Lodge LOSH3



- UR5
- 6.25" dia
- Round
- Hand clean only
- Walnut Finished

Fits: Lodge HMSB



- UOS7
- 8-3/4"L
- Oval
- Hand clean only
- Walnut Finished

Fits: Lodge HM16OS



- UOS9
- 10-1/2" L
- Oval
- Hand clean only
- Walnut Finished

Fits: Lodge HOSD



- UOS6
- 7-3/4" L
- Oval
- Hand clean only
- Walnut Finished

Fits: Lodge HMSOV



- UR16
- 8-1/2" dia
- Round
- Hand clean only
- Walnut Finished

Fits: Lodge L5RPL3

Aprons



CKA-1B CKA-1R CKA-1STR

- Waist Apron
- 3 pockets, machine wash & dry
- Wrinkle resistant
- Cotton / poly blend

| Item # | L x W | Color |
|----------|-------------------|--------|
| CKA-1B | 21-3/4" x 12-1/2" | Black |
| CKA-1R | | Red |
| CKA-1STR | | Stripe |



CKA-2B CKA-2STR

- Bistro Apron
- 2 pockets, machine wash & dry
- Wrinkle resistant
- 65/35 poly-cotton blend

| Item # | L x W | Color |
|----------|-----------|--------|
| CKA-2B | 32" x 28" | Black |
| CKA-2STR | | Stripe |



CKA-3B CKA-3R

- Bib Apron, mid length
- 3 pockets, machine wash & dry
- Wrinkle resistant
- 65/35 poly-cotton blend

| Item # | L x W | Color |
|--------|---------------|-------|
| CKA-3B | 24" x 27-1/2" | Black |
| CKA-3R | | Red |



CKA-4B CKA-4R CKA-4STR

CKA-5B

- Bib Apron, full length, adjustable neck strap
- 2 pockets, machine wash & dry
- Wrinkle resistant
- 65/35 poly-cotton blend

| Item # | L x W | Color |
|----------|---------------|--------|
| CKA-4B | 31-1/2" x 27" | Black |
| CKA-4R | | Red |
| CKA-4STR | | Stripe |
| CKA-5B | 33" x 26" | Black |
| CKA-5R | | Red |

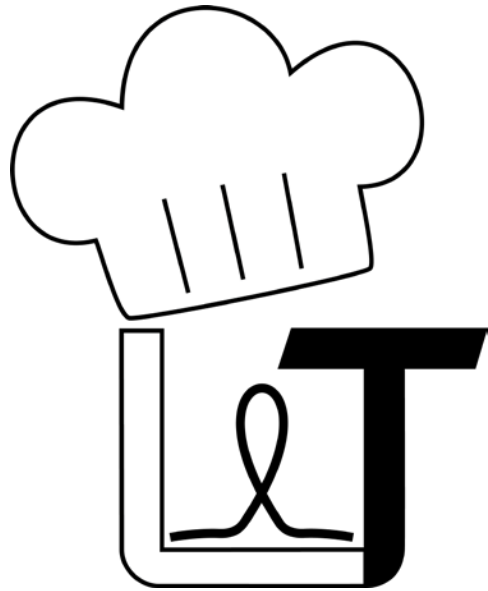

Plasticware

Dishwasher Racks



NSF

- JW-16 / JW-25
- 16 or 25 compartment glass rack
- Extender available
- 6 per case



NSF

- JW-25B / JW-64B
- 25 or 64 compartment plate & tray rack
- Extender available
- 6 per case



NSF

- JW-C
- Cultery rack
- Extender available
- 6 per case

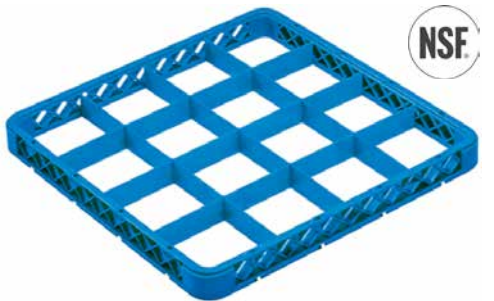

NSF

- JW-162 / JW252
- 16 or 25 compartment extender
- 6 per case



NSF

- JW-P
- Open extender
- 16 per case



NSF

- JW-8BH
- 8 Compartment
- Cutlery basket

Trash Cans / Containers



White polyethylene container

| Item # | Volume |
|-----------|---------|
| JW-CR38W | 10 gal. |
| JW-CR76W | 20 gal. |
| JW-CR120W | 30 gal. |



Black polyethylene container

| Item # | Volume |
|-----------|---------|
| JW-CR76E | 20 gal. |
| JW-CR120E | 30 gal. |



Recycling polyethylene container

| Item # | Volume |
|--------------|-----------------|
| JW-CR76S-BLK | 20 gal. / Black |
| JW-CR76S-GRY | 20 gal. / Grey |



| Item # | Description |
|----------|----------------------------|
| JW-CRC2P | 20 gal container lid, grey |
| JW-CRC3P | 30 gal container lid, grey |

Food Containers

- Polypropylene body
- Available in white or clear
- NSF listed



JW-P-60C



JW-P-061C



JW-P-67C



JW-P-67P

| Item # | Volume | Style |
|----------|--------|-------|
| JW-P-60C | 2QT | Clear |
| JW-P-61C | 4QT | |
| JW-P-62C | 6QT | |
| JW-P-63C | 8QT | |
| JW-P-64C | 12QT | |
| JW-P-65C | 18QT | |
| JW-P-66C | 22QT | |
| JW-P-67C | 12QT | |
| JW-P-68C | 18QT | |
| JW-P-69C | 33QT | |
| JW-P-70C | 52QT | |
| JW-P-71C | 68L | |
| JW-P-74C | 88L | |
| JW-P-60P | 2QT | |
| JW-P-61P | 4QT | |
| JW-P-62P | 6QT | |
| JW-P-63P | 8QT | |
| JW-P-64P | 12QT | |
| JW-P-65P | 18QT | |
| JW-P-66P | 22QT | |
| JW-P-67P | 12QT | |
| JW-P-68P | 18QT | |
| JW-P-69P | 33QT | |
| JW-P-70P | 52QT | |
| JW-P-71P | 68L | |
| JW-P-74P | 88L | |

Round Containers

- Polycarbonate body
- Available in white or clear
- NSF listed



JW-P-101C

JW-P-102P

| Item # | Volume | Style |
|-----------|--------|-------|
| JW-P-101C | 2QT | Clear |
| JW-P-102C | 4QT | |
| JW-P-103C | 6QT | |
| JW-P-104C | 8QT | |
| JW-P-101P | 2QT | White |
| JW-P-102P | 4QT | |
| JW-P-103P | 6QT | |
| JW-P-104P | 8QT | |

Round Container Lids

- Polycarbonate
- Available in white or clear
- NSF listed



JW-P-091C

JW-P-092P

| Item # | Fits | Style |
|-----------|-------------|-------|
| JW-P-091C | 2 or 4 QT | Clear |
| JW-P-092C | 6 or 8 QT | |
| JW-P-093C | 18 or 22 QT | |
| JW-P-091P | 2 or 4 QT | White |
| JW-P-092P | 6 or 8 QT | |
| JW-P-093P | 18 or 22 QT | |

Rectangular Container Lids



JW-P-080

JW-P-081

JW-P-082

- Polyethylene
- Available in red, green, and blue

| Item # | Fits |
|----------|-------------------|
| JW-P-080 | 2 or 4 QT |
| JW-P-081 | 6 or 8 QT |
| JW-P-082 | 12 or 18 or 22 QT |

Container Lids



JW-P-083C



JW-P-083P

| Item # | Size | Style |
|-----------|-----------|-------|
| JW-P-083C | Small box | Clear |
| JW-P-083P | | White |
| JW-P-084C | Big box | Clear |
| JW-P-084P | | White |

Ingredient Bins



JW-S102



JW-S40

- S102 & S120 are equipped with 3" casters
- White body
- NSF listed

| Item # | Description |
|---------|----------------------------|
| JW-S102 | 27 Gal. with sliding lid |
| JW-S120 | 31.7 Gal. with sliding lid |
| JW-S20 | 5.3 Gal ingredient bin |
| JW-S40 | 10.6 Gal. ingredient bin |

Food Carriers



JW-SIF



JW-EPP160
JW-EPP180
JW-EPP400



- JW-SIF / JW-EPP (foam)
- Single wall food carrier
- Grey
- NSF listed

| Item # | Outer Size |
|-----------|-----------------------------|
| JW-SIF | 18-7/8" x 26-7/8" x 24-1/2" |
| JW-EPP160 | 23-5/8" x 15-3/4" x 10-1/4" |
| JW-EPP180 | 23-5/8" x 15-3/4" x 12-1/2" |
| JW-EPP400 | 25-1/4" x 17-1/8" x 24-7/8" |

Servewares

Water Pitchers



- Clear water pitcher

JW-JW-609

| Item # | Volume |
|--------|--------|
| JW-601 | 60 oz |
| JW-603 | 32 oz |
| JW-609 | 64 oz |

Heavy Duty Serving Trays



JW-P-1009201

| Item # | Diameter |
|--------------|------------------|
| JW-P-1009201 | 11" |
| JW-P-1009202 | 14" |
| JW-P-1009204 | 22" x 27" (Oval) |

Bar Supplies

Bar Caddy & Bar Mats



JW-B5B

| Item # | Compartment |
|--------|-------------|
| JW-B3B | 3 |
| JW-B4B | 4 |
| JW-B5B | 5 |
| JW-B6B | 6 |



JW-BC

- Bar Caddy
- 4 slots with lid holder
- Plastic



JW-BMT

- Black plastic bar mat

Squeeze Bottles



JW-BSD series

| Item # | Size | Color |
|----------|-------|---------------------------------|
| JW-BSD8 | 8 oz | Clear White Yellow Red |
| JW-BSD12 | 12 oz | |
| JW-BSD24 | 24 oz | |
| JW-BSD32 | 32 oz | |

Organizer



JW-VO33

| Item # | Description |
|---------|---------------------|
| JW-VO23 | 6 Compartment, Grey |
| JW-VO33 | 9 Compartment, Grey |

Dolly



JW-ST

- Rack dolly with handle
- Polypropylene



JW-RCD

- Round dolly
- Holds up to 400 lbs
- Black with 5 casters



JW-RT

- Rack dolly without handle
- Polypropylene



JW-FOC

- Food carrier dolly



Watson

Chinaware

Colored Platters



COB-1352



CMR-1352



CSF-1352

- Oval platter
- Microwave & dishwasher safe
- Oven safe
- Ceramic

| Item # | Size | Case Qty | Color |
|-----------|------------------|-------------|------------|
| COB-0975 | 9-3/4" x 7" | 1 DZ / Case | Ocean Blue |
| COB-1150 | 11-1/2" x 8-3/4" | 1 DZ / Case | |
| COB-1350 | 13-1/2" x 9-3/4" | 6 EA / Case | |
| CMR- 0975 | 9-3/4" x 7" | 1 DZ / Case | Maroon |
| CMR-1150 | 11-1/2" x 8-3/4" | 1 DZ / Case | |
| CMR-1350 | 13-1/2" x 9-3/4" | 6 EA / Case | |
| CSF-0975 | 9-3/4" x 7" | 1 DZ / Case | Sunflower |
| CSF-1150 | 11-1/2" x 8-3/4" | 1 DZ / Case | |
| CSF-1350 | 13-1/2" x 9-3/4" | 6 EA / Case | |



LIT Cooking

FreeStanding Electric Strip Heater



- Infrared heating element
- With on/off toggle switch
- Indicator light, Aluminum shell



| Item # | Size | Power |
|---------|---------------------------|-----------------------------------|
| AEBH-24 | 24" x 6-3/4" x 2-3/4" | 120v/60/1-ph, 500 watts, 4.2 amps |
| AEBH-30 | 30" x 6-3/4" x 2-3/4" | 120v/60/1-ph, 650 watts, 4.2 amps |
| AEBH-36 | 36-1/4" x 6-3/4" x 2-3/4" | 120v/60/1ph, 850 watts, 7.1 amps |
| AEBH-42 | 42-1/4" x 6-3/4" x 2-3/4" | 120v/60/1ph, 1050 watts, 7.1 amps |
| AEBH-48 | 48" x 6-3/4" x 2-3/4" | 120v/60/1ph, 1200 watts, 7.1 amps |
| AEBH-54 | 54" x 6-3/4" x 2-3/4" | 120v/60/1ph, 1425 watts, 7.1 amps |
| AEBH-60 | 60" x 6-3/4" x 2-3/4" | 120v/60/1ph, 1550 watts, 7.1 amps |
| AEBH-72 | 72" x 6-3/4" x 2-3/4" | 120v/60/1ph, 1725 watts, 7.1 amps |

Strip Heaters Hardware



| Item # | Description |
|----------|--|
| AEBH-CLS | C-Leg stand Designer For use Bar heater (Bar Heater Not Include) (2 per set) |
| AEBH-TLS | T-Leg stand Designer For use Bar heater (Bar Heater Not Include) |

Countertop Warmer



AECFW-12



AECFW-43

- Wet operation, adjustable thermostat
- Cycling indicator pilot light
- Stainless steel construction
- 1500 watts, NEMA 5-15P



| Item # | Size | Power |
|----------|---------------------------------|------------------------|
| AECFW-12 | Accepts 12" x 20" full size pan | 120v/60/1ph, 13.6 amps |
| AECFW-43 | Holds (4) each 1/3 size pans | 120v/60/1ph, 12.5 amps |

Chip Warmer



AECW26

- Top load style, first in/first out design
- Clamp-on removable heating module
- Adjustable rear-mounted thermostat



AECW46

| Item # | Capacity | Power/Plug |
|--------|-----------|---|
| AECW26 | 26 gallon | 120v/60/1-ph, 1500 watts, 12.5 amps, NEMA 5-15P |
| AECW46 | 46 gallon | |

Convection Ovens



AECOV-4FS



AECOV-4HS

- Electric, countertop, Stainless steel construction
- Heat settings range from 175°F to 500°F
- Manual time, temperature & humidity controls



| Item # | Dimension | Power | Plug |
|-----------|-----------|-------------------------------------|------------|
| AECOV-4FS | Full Size | 208-240v/60/1-ph, 5.9kW, 24.6 amps | NEMA 6-30P |
| AECOV-4HS | Half Size | 208-240v/60/1-ph, 2.8kW, 11.25 amps | NEMA 6-15P |



- Electric/ Nat Gas (gas supply 3/4" NPT)
- Stainless steel exterior
- Single-deck, (5) wire racks
- Heat settings range from 150°F to 550°F
- Manual controller, interior lighting



| Item # | Dimension | Power |
|----------|----------------|-------------------------------|
| AECVD-1E | Standard depth | 240v/60/1ph, 11kw, 45.8 amps |
| AECVD-1G | | Nat Gas (gas supply 3/4" NPT) |

Can Racks



AECR-FS



AECR-HS



- All welded aluminum
- Caster all with brakes
- Can opener not included

| Item # | Dimension | Capacity |
|---------|--------------------|---|
| AECR-FS | 25"W x 35"L x 77"H | (9) Levels each hold (18) #10 or (24) #5 cans |
| AECR-HS | 25"W x 35"L x 42"H | |

Reach-in Refrigerator Storage Pan Rack



ATS-AERR-FS



- End loading, open sides
- Designed to holds (16) 18" x 26" pans, 2-7/8" spacing between each tier
- Welded angle slides, aluminum

| Item # | Dimension | Capacity |
|---------|------------------------|---------------------|
| AERR-FS | 20-1/4"W x 24"D x 51"H | (16) 18" x 26" pans |

Warming Drawer



AEDW-1



- Stainless steel construction
- Free standing
- Individual thermostat controls
- Moist/crisp door vents
- 5" adjustable legs, 120v/50/60-1



AEDW-2



- Stainless steel construction
- Free standing
- Individual thermostat controls
- Moist/crisp door vents
- 5" adjustable legs, 120v/50/60-1



AEDW-3



- Stainless steel construction
- Free standing
- Individual thermostat controls
- Moist/crisp door vents
- 5" adjustable legs, 120v/50/60-1

| Item # | Dimension | Power |
|--------|----------------------------|------------|
| AEDW-1 | 27-3/4"W x 21"D x 14-7/8"H | 450 watts |
| AEDW-2 | 27-3/4"W x 21"D x 24-1/4"H | 900 watts |
| AEDW-3 | 27-3/4"W x 21"D x 33-5/8"H | 1350 watts |

Can Opener



ATS-AECO-1



ATS-AECO-1G



ATS-AECO-1K

| Item # | Description |
|---------|--|
| AECO-1 | Can Opener, #1 Manual Heavy Duty , with stainless steel base |
| AECO-1G | Gear for use #1 Can Opener |
| AECO-1K | Knife for use #1 Can Opener |

Film Wrapping Dispenser



AEFW-18



| Item # | Item Size | Description |
|---------|-----------------------|---|
| AEFW-18 | 26"W x 22-1/2"D x 9"H | Counter type, aluminum & stainless steel construction, 6" x 15" teflon covered hot plate, mounting axles, holds one film roll with 3" dia. core, 115v/60/1-ph |

Pro Swinging Traffic Door



| Item # | Size | Description |
|---------|-----------|---|
| AEKD-30 | 30" x 84" | Tempered aluminum with satin anodized finish, 9" x 14" window |
| AEKD-36 | 36" x 84" | |

Wok Range



- Stainless steel material
- Natural Gas
- 13" opening, 12" heavy duty legs



| Item # | Dimension | BTU |
|--------------|---|-------------|
| AEHP05WR-ICD | 18" x 26" or (24) 12" x 20" x 2 1/2" pan capacity | 95,000 BTU |
| AEHP16WR-ICD | 18" x 26" or (36) 12" x 20" x 2 1/2" pan capacity | 125,000 BTU |

Heated Holding & Proofing Cabinet

- Full insulated
- Aluminum construction
- Removable bottom mount control module
- Thermostat to 200°F
- 120v/60/1-ph



AEHP05WR-ICD



AEHP16WR-ISDD



AEHP36-ICD



AEHP16WR-ICD



AEHP36-ISDD



| Item # | Dimension | Door Style |
|---------------|---|----------------------|
| AEHP05WR-ICD | 18" x 26" or (24) 12" x 20" x 2 1/2" pan capacity | Clear polycarbonate |
| AEHP16WR-ICD | 18" x 26" or (36) 12" x 20" x 2 1/2" pan capacity | Clear polycarbonate |
| AEHP36-ICD | (36) 18" x 26" pan capacity | Clear polycarbonate |
| AEHP36-ISDD | (36) 18" x 26" pans capacity | Solid aluminum dutch |
| AEHP16WR-ISDD | (18) 18" x 26" pan capacity | Solid aluminum dutch |



We've specialized in fulfilling foodservice product requirements
for over 30 years



Warranty info



LIMITED WARRANTY: ATS MFG warrants all MET Stainless Steel & FLO Faucet products, when properly installed and subject to normal use, are free from defects in material or workmanship for a period up to one (1) year.

With regard to these equipment, a defect shall refer to a variance from the design specifications that prohibit the Equipment from operating for its intended use. The Warranty provided by ATS MFG does not impose any duty or liability upon ATS MFG for degradation that occurs in the normal course over time, or due to improper installation of the Equipment by Purchaser or their representative.

Determination of repair or replacement will be at the sole discretion of ATS MFG.

EXCLUSION FROM WARRANTY COVERAGE:

- A. Any damage occurring, at any time, during shipping of Equipment unless otherwise provided for in the Agreement. When returning Equipment to ATS MFG for repair or replacement, Purchaser assumes all risk of loss or damage, and agrees to use any shipping containers that might be provided by ATS MFG and to ship the Equipment in the manner prescribed by ATS MFG;
- B. Any damage caused by improper installation and/or use, overloading, accident, improper storage, or neglect, alterations, modifications, or additions;
- C. Any statement made about the product by salesman, dealers, distributors or agents, unless such statements are in a written document signed by an officer of ATS MFG. Such statements are not included in a signed writing do not constitute warranties, shall not be relied upon by Purchaser and are not part of the contract of sale.

PURCHASER'S INSPECTION UPON RECEIPT OF EQUIPMENT: All Equipment shall be carefully inspected by Purchaser upon receipt, be installed by persons who are trained and certified professionals with respect to such installation, and be installed, used, repaired and maintained by Purchaser in accordance with all applicable local laws, codes and regulations.

ASSIGNMENT OF RIGHTS: The Warranty contained herein extends only to the original Purchaser of the Equipment and no attempt to extend the Warranty to any subsequent user or transferee of the Equipment shall be valid or enforceable without the express written consent of ATS MFG. Any attempt by Purchaser to assign this Warranty shall render the Warranty.

FES Brands North America

2024 Catalog

Address:
1750 Stone Ridge Dr. Suite B
Stone Mountain, GA 30083

FESbrands.us
Email: hello@fesbrands.us
TEL: 470-709-4628

